

Rinnai

1ST CHOICE

HOT WATER

(07) 3423-3754

Continuous Flow Water Heater

Operation & Installation Manual

To Suit Water Heater Models

Infinity 26 Touch	REU-AM2626WDL
Infinity 26	REU-AM2626WD
Infinity 20	REU-AM2024WD
Infinity 16	REU-AM1620WD
Infinity 12	REU-AM1220WD
B26	REU-A2626WB
B20	REU-A2024WB
B16	REU-A1620WB

This appliance must be installed in accordance with:

- Manufacturer's Installation Instructions
- Current AS/NZS 3000, AS/NZS 3500 & AS/NZS 5601
- Local Regulations and Municipal Building Codes including local OH&S requirements

This appliance must be installed, maintained and removed by an Authorised Person.

For continued safety of this appliance it must be installed and maintained in accordance with the manufacturer's instructions.



This Appliance complies
with AS 3498:2009
SATGLOBAL LIC.W208



N10378



The Australian
Gas Association
All Rinnai gas products
are A.G.A. certified.





OPERATION TABLE OF CONTENTS

Warnings & Important Information	4
Regulatory Information	4
Notice to Victorian Consumers	4
Warning About Hot Water	4
Operational Safety Information	5
Features & Benefits	7
Water Temperature Control	8
Maximum Delivery Temperatures	8
Operation Without Water Controllers	8
Rinnai Water Controllers	8
Location	8
Water Resistance	8
Temperature Control	9
Water Controller Combinations & Configurations	9
Wired Only Configurations	9
Combined Wireless & Wired Configurations	9
Universal Water Controller (MC-601Q) Operation	10
Turning On	10
Adjusting Temperature	10
Transferring Priority	10
Water Controller Combinations & Configurations	10
Smartstart Pre-Heat System	11
Preheat Function	11
Preheat Operation	11
Water Controller Functions	11
Trouble Shooting	12
Error Codes	12
No power display Wireless Water Controller (when fitted)	13
Troubleshooting Without Water Controllers	13
Service	13
Installation Table of Contents	14
Contacts	28

WARNINGS & IMPORTANT INFORMATION

REGULATORY INFORMATION

Your Rinnai Continuous Flow water heater has been certified by the Australian Gas Association. The A.G.A. Certification Number is shown on the data plate.

This Appliance must be installed correctly by an authorised person. The installation of gas, water, and electricity must conform to local regulations.

The installation must also comply with the instructions supplied by Rinnai.

All dimensions referred to in these instructions are in millimetres, unless otherwise specified.

Please keep this instruction booklet in a safe place for future reference.

Notice to Victorian Consumers

This appliance must be installed by a person licensed with the Plumbing Industry Commission.

Only a licensed person will have insurance protecting their workmanship.

So make sure you use a licensed person to install this appliance and ask for your Compliance Certificate. For Further information contact the Plumbing Industry Commission on 1300 815 127.

WARNING ABOUT HOT WATER



Hot water can cause scalding. Those most at risk are children and disabled, elderly and infirm persons. (65°C water can severely burn a child in half a second).

Rinnai have water heater models which limit the delivery temperature to 50°C which significantly reduces the scald hazard. Temperature limiting devices may also be able to be fitted. Contact Rinnai for further information.

Always test the water temperature before use, such as when filling a bath or basin or entering a shower, to ensure it is suitable for the application and will not cause scald injury.

Always supervise children whenever they are in the bathroom or near other sources of hot water. Ensure any hot water taps are closed firmly after use.

Operational Safety Information



This appliance is not intended for use by persons (including children) with reduced physical, sensory or mental capabilities, or lack of experience and knowledge, unless they have been given supervision or instruction concerning use of the appliance by a person responsible for their safety. Children should be supervised to ensure that they do not play with the appliance.

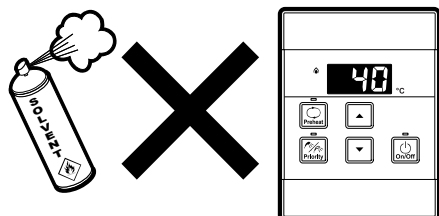

To clean your water controller(s) use a soft damp cloth with a mild detergent.

DO NOT use solvents!

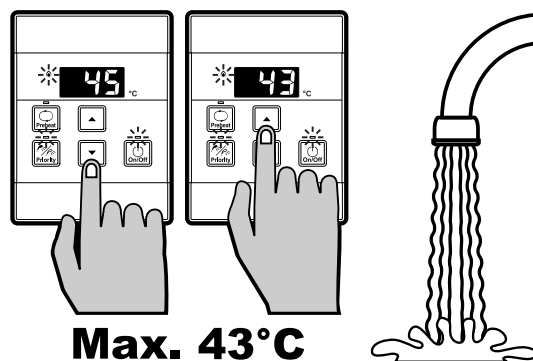

Max. 43°C

Whilst hot water outlets are open the set temperature may be lowered. However they cannot then be raised above 43°C. In addition transfer of 'priority' between controllers is not possible. These are safety features.

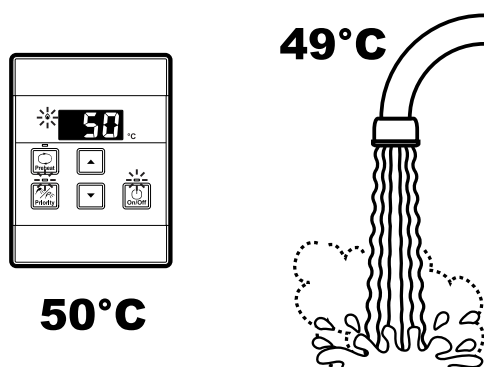

50°C

Depending on the weather conditions and the length of the pipe between the hot water unit and the outlet in use, there may be a variation between the temperatures displayed at the water controller(s) and the temperature of the water at the outlet.

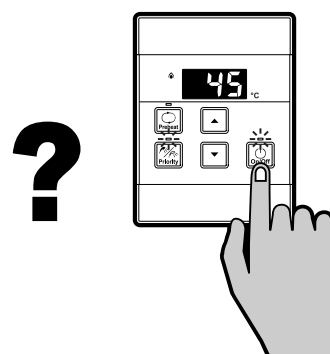

There is no need to turn the water controller(s) off after use. However, if you prefer to turn the water controller(s) off, your selected temperatures to a maximum of 50°C will be stored in the system memory at all times whilst mains power remains connected.

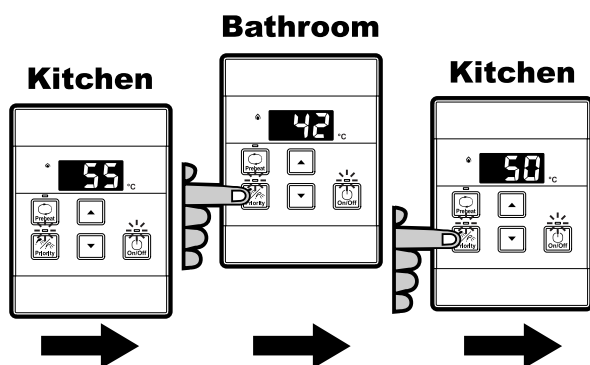

As a safety precaution, if a Kitchen Water Controller's temperature is set above 50°C, transferring and then returning 'priority' to the Kitchen Water Controller will result in a default set temperature of 50°C being selected. This is a safety feature.

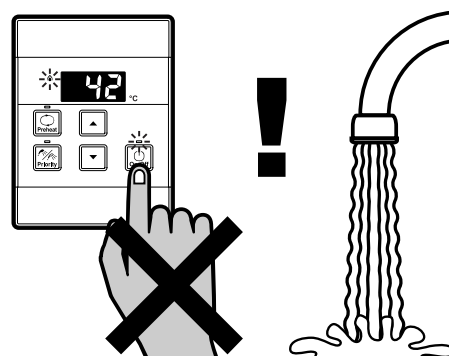

DO NOT push the On/Off button on any Water Controller when the water heater 'In Use' indicator is illuminated as this will turn off the water heater causing the water to go cold. Someone maybe in the middle of having a shower or filling a bath.



The range of Rinnai continuous flow water heaters referred to in this manual are incompatible with solar water heating systems. A dedicated range of solar compatible continuous flow water heaters is available from Rinnai.

If the supply cord is damaged, it must be replaced by the manufacturer, its service agent or similarly qualified persons in order to avoid a hazard.

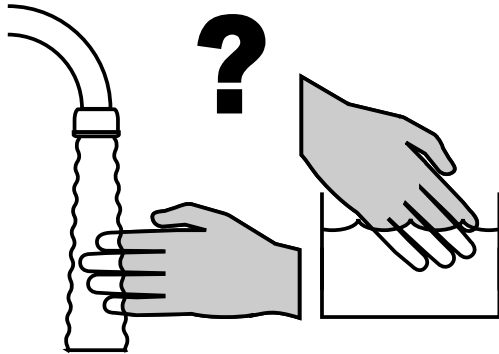

Always check water temperature carefully before use. Refer to the **"WARNING ABOUT HOT WATER"** on page 4 for important safety information.

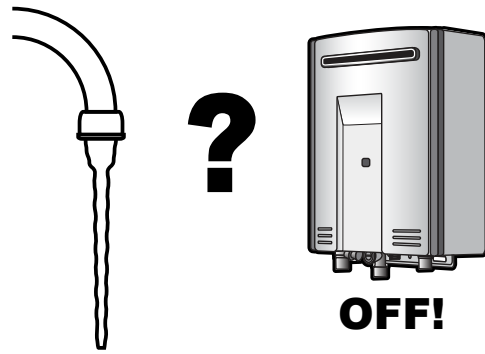

At low water flows, the hot water unit may extinguish without warning. Opening the tap further will restart the heating appliance.

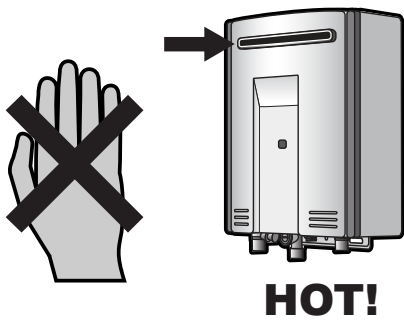

DO NOT touch the unit cover or the flue outlet.
DO NOT insert objects into the flue outlet.
DO NOT spray water directly into the flue outlet.
 Keep, trees, shrubs, etc. well clear of the flue outlet.
 On colder days steam may discharged from the flue outlet. This condition is normal for high efficiency appliances and does not indicate a fault.



DO NOT Spray aerosols in the vicinity of this appliance while it is in operation.
DO NOT use or store flammable materials in or near this appliance.
DO NOT place articles on or against this appliance.
DO NOT modify this appliance.
DO NOT store pool chemicals near this appliance.

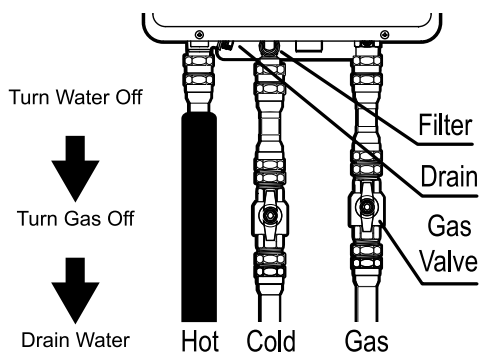

If freezing conditions are expected, turn off water and gas, and drain all water from the appliance. If power and the automatic frost protection are connected, freezing will be prevented. (Anti-frost protection is fitted as standard equipment on all hot water units).

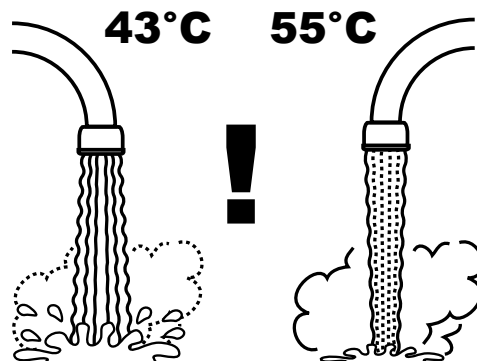

The delivered water temperature is controlled automatically. The flow may vary depending on the delivery temperature selected and the ambient water temperature.

FEATURES & BENEFITS

Congratulations on purchasing the latest technology temperature controlled Rinnai continuous flow water heating system.

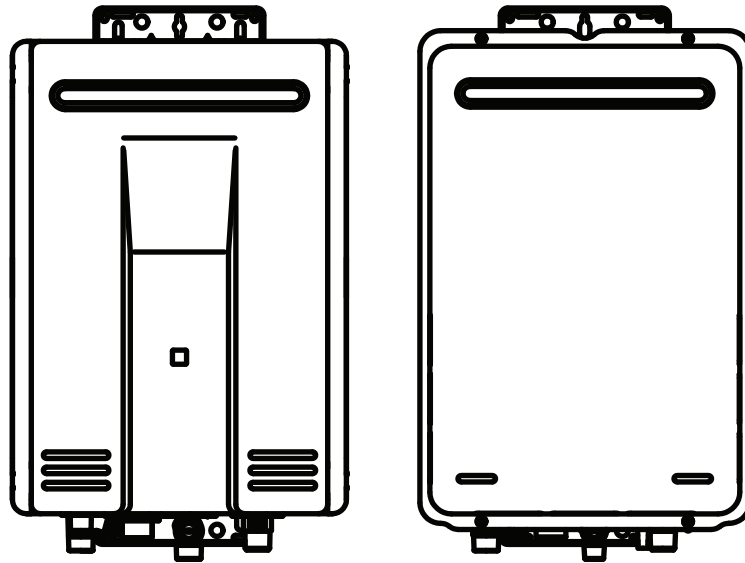

- The Rinnai Continuous Flow water heater products **NEVER RUN OUT** of hot water. Whilst electricity, water and gas supplies are connected, hot water is available whenever hot water taps are open.
- Built into the main micro-processor is the facility to **LIMIT THE MAXIMUM TEMPERATURE** of the hot water supplied. The water temperature may be limited to various values. This is particularly useful when the hot water unit is installed where young children or the infirm may be using the hot water.
- The Rinnai Continuous Flow water heater products are Fan-Assisted (power flued) appliances. This makes them **COMPACT**, saving both floor and wall space.
- The temperature of hot water is **CONSTANTLY MONITORED** by a **BUILT-IN SENSOR**. If the temperature of the hot water rises to more than 3°C above the selected temperature the burner is turned OFF and only turned ON again when the temperature falls below the selected temperature.
- The burner lights automatically when the hot water tap is opened, and goes out when the tap is closed. **IGNITION IS ELECTRONIC**, so there is no pilot light. When the hot water tap is off, no gas is used.
- 'Deluxe' or 'Universal' Water Controllers are available as an optional extra. Depending on the models chosen, these offer the following features:
 - Bath fill function (Deluxe Bathroom Control Only).
 - Voice Prompting (Deluxe Control Only).
 - Clock (Deluxe Control Only).
 - Up to four water controllers can be fitted. See page 9 for details.

For further information regarding Wireless and Deluxe water controllers please contact Rinnai or visit www.rinnai.com.au.

- The "Smartstart®" system when fitted can pre-heat the water in the pipe-work between the water heater and the hot water outlets. This results in water savings and reduces waiting time for heated water at the outlets.
- Operating **NOISE LEVEL IS VERY LOW**.
- **ERROR MESSAGES ARE DISPLAYED** on the Water Controllers and Status Monitor*, assisting with service. *All models in the range covered by this manual have a "Status Monitor", except B16,B20 & B26.
- The **Infinity 26 Touch (REU-AM2626WDL)** water heater model is supplied with one "MC-503" wireless water controller that is pre-programmed as a master controller. Additional 'MC-503' wireless water controllers are available as an optional extra. Please refer the separate wireless operation manual for instructions on how to use the supplied wireless water controller.

WATER TEMPERATURE CONTROL

MAXIMUM DELIVERY TEMPERATURES

Rinnai continuous flow water heaters are factory pre-set to various maximum delivery temperatures depending on model and their intended application. For the majority of applications, the factory pre-set temperature is appropriate.

In the unlikely event this is not the case this setting can be increased or decreased by an authorised person such as a licensed plumber.



This does not apply to "50 degree compliant" models. To meet the regulatory requirements the maximum delivery temperature is factory set and sealed.

For model specific information in regards to the factory pre-set temperature of your appliance refer to "Table 3. Maximum Delivery Temperatures" on page 27. The appliance model number can be found on the dataplate, which is located on the left hand side of appliance.

OPERATION WITHOUT WATER CONTROLLERS

Rinnai Continuous Flow water heater products do not use a pilot light. When installed and operated without water controllers, the opening of any hot water tap will automatically start the appliance. Once water is flowing through the appliance the burner will be ignited by electronic ignition. When the hot water tap is closed and water flowing through the appliance has stopped the burner flame will extinguish.

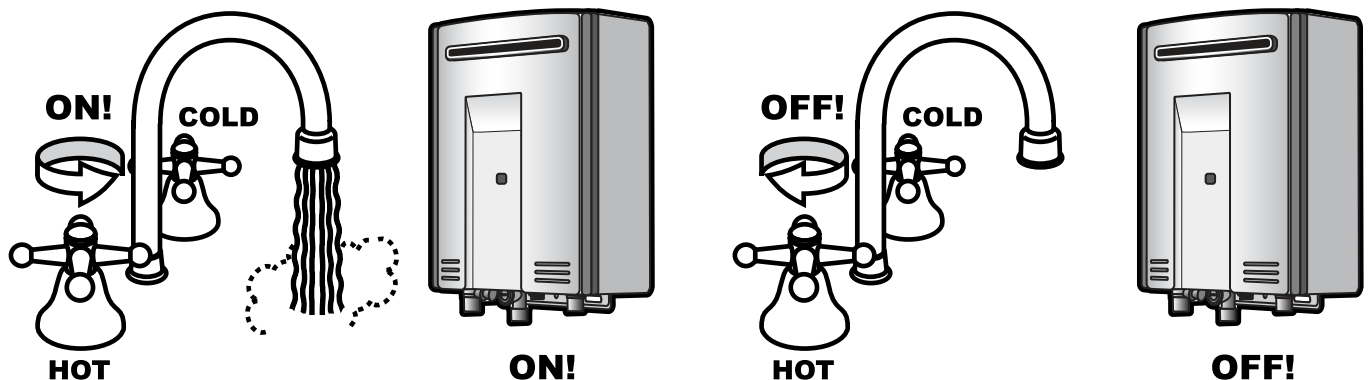

RINNAI WATER CONTROLLERS



Other manufacturers water controllers are **NOT** compatible with Rinnai water heaters. Rinnai water controllers brought in from other countries are also **NOT** compatible with Rinnai appliances sold in Australia.

Water controllers **MUST NOT** be used with any Solar Boost water heater.

Water controllers are available as an optional extra. Wireless, Universal and Deluxe water controllers can be used together and will function as described in the Operation Sections of this manual. Refer to "Water Controller Combinations & Configurations" on page 9 to confirm the maximum number and combination of water controllers that can be fitted to your water heater model.

Location

Water controllers must be installed in shaded and clean locations. They should be fitted out of reach of children (suggested height from floor to be at least 1500 mm).

Water Resistance

The MC-601Q universal water controller is a water resistant device, however excessive exposure to water such as immersion may result in damage to the water controller. Durability of water controllers is improved when positioned outside of the shower recess.



Controllers **MUST BE** installed at least 400 mm above the highest part of a sink, basin or bath.

DO NOT immerse the water controller into water.

AVOID direct exposure to water or steam as these conditions may cause a malfunction.

ALWAYS AVOID exposure to water when the battery compartment is open.

When cleaning your water controller use **ONLY** a damp cloth and a mild detergent.

Temperature Control

Water controllers allow precise temperature control by the user. When used correctly, the hot water unit will deliver the selected temperature, even when the water flow is varied, or more than one tap is in use.

Only one MC model water controller can be designated as a 'Master' water controller and this is normally used in the kitchen. All the remaining water controllers are designated as 'Sub' water controllers and are for use in bathrooms, toilets and laundries. The maximum temperature limit for all 'Sub' water controllers is restricted to 50°C to minimise the risk of burns in these areas.

Each water controller can be individually programmed, however the water heater can only deliver one set temperature at any time. The available temperatures (°C) are as follows:

Water Controller Temperatures (°C)**	Master (MC)	37, 38, 39, 40, 41, 42, 43, 44, 45, 46, 48, 50, 55*, 60*, 65*
	Sub (MC or BC)	37, 38, 39, 40, 41, 42, 43, 44, 45, 46, 48, 50

For hygiene in sanitary areas such as bathrooms, the suggested temperature should be 37°C ~ 43°C.

The above is a suggestion only, as you may find higher or lower temperatures more comfortable, however maintaining lower temperatures also helps to save energy.

To obtain water temperatures lower than 37°C, simply open the cold water tap and add cold water until the desired lower temperature is reached.



The temperature of outgoing hot water is constantly monitored by a built-in sensor. If the temperature of the outgoing hot water rises to more than 3°C above the selected temperature shown on the digital monitor or the pre-set limit when water controllers are not fitted, the burner will automatically go out. The 'in use' indicator  will also go out. The burner will ignite again once the outgoing hot water temperature falls to that shown on the digital monitor (or the pre-set limit of the appliance)

* Temperature may not be available on all installations. Some Rinnai Continuous Flow water heaters can be programmed to deliver higher temperatures from the master water controller, or may be programmed to restrict the maximum available delivery temperature. Contact Rinnai for more details.

** Temperature limiting devices (where fitted) may further control what maximum delivery temperature is available to outlets.

Universal and Wireless and water controllers allow temperature selection only. Deluxe water controllers allow temperature selection, have a clock function and the Deluxe Bathroom water controller has a shower saver / bath fill function is also available, contact Rinnai for further information regarding Wireless and Deluxe water controllers or visit www.rinnai.com.au.

WATER CONTROLLER COMBINATIONS & CONFIGURATIONS

Wired Only Configurations

- A maximum of 4 water controllers can be fitted. Any combination of deluxe and universal controllers can be used with the following limitations:
- Only **ONE** master controller can be installed. This can be a MC-100V, or a MC-601Q (when programmed as a master controller). Note that when a MC-100V is fitted it will always functions as a master controller, this is the default setting and can not be changed.
- Up to **TWO** BC-100V water controllers can be installed.
- The **FOURTH** water controller in any installation MUST BE a MC-601Q.

Combined Wireless & Wired Configurations

- A maximum of 4 water controllers can be fitted. Any combination of deluxe, universal and wireless controllers can be used with the following limitations:
- Only **ONE** master controller can be installed. This can be a MC-100V, a MC-601Q (when programmed as a master controller) or a MC-503RC-S water controller. Note that when a MC-100V is fitted it will always functions as a master controller, this is the default setting and can not be changed.
- Up to **TWO** BC-100V water controllers can be installed.
- The **FOURTH** water controller in any installation MUST BE a MC-503RC-S or a MC-601Q.

UNIVERSAL WATER CONTROLLER (MC-601Q) OPERATION

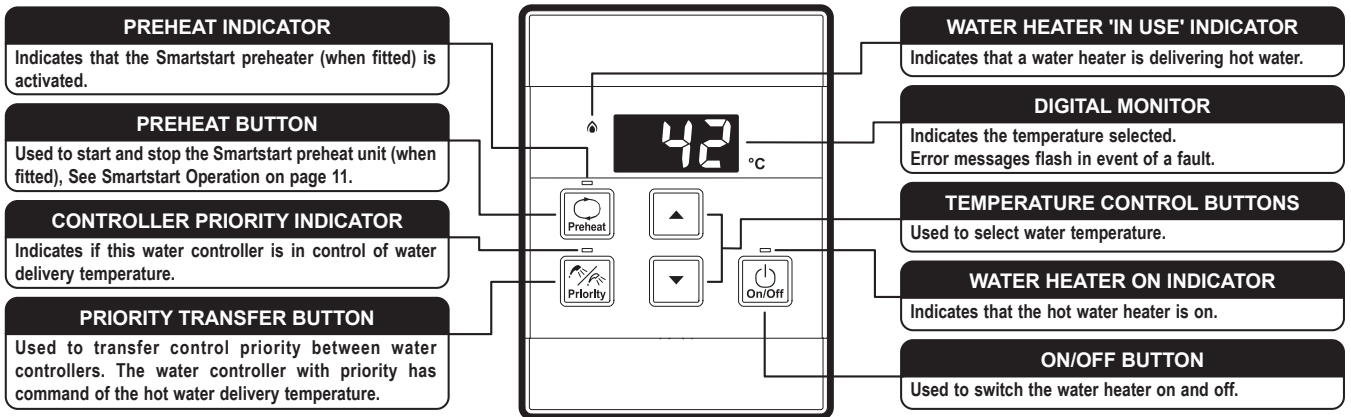

Turning On

If the water controller is switched off (No digits displayed in the digital monitor window) press the On/Off button once. The ON indicator will illuminate, indicating that the hot water unit will be ready to supply hot water once a hot water tap is opened.

Adjusting Temperature

Select the desired temperature using the Hot water temp ▲ or ▼ buttons until the required temperature is displayed on the digital monitor.

To operate the hot water unit, open any hot water tap. This will automatically light the burner providing hot water. The water heater 'In Use' indicator will illuminate on the water controller(s).

Once the hot water is running, if the set temperature is either too hot or cold press the Hot water temp ▲ or ▼ buttons until the desired temperature is reached.

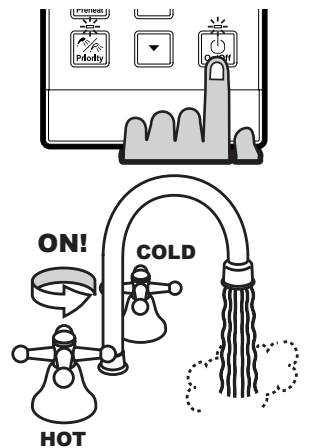

Whilst hot water outlets are open, the set temperature may be lowered to a minimum of 37°C. For safety, it cannot then be raised above 43°C until all hot water taps are closed.

If the water heater is turned 'Off' whilst hot water taps are open it can not be turned back 'On' until all hot water taps have been closed.

Temperatures higher than 50°C **MUST NOT** be able to be selected on controllers installed in bathrooms, ensuites or toilets. This is to help reduce the risk of burns from hot water. If this is not the case, the controllers have been incorrectly installed. **CONTACT YOUR INSTALLER.**

The 'beep' sound can be muted by pressing the ▲ and ▼ buttons simultaneously for more than 3 seconds. To cancel sound muting, simply repeat the process.



Always check outlet water temperature before use. The parent / carer **MUST** check the temperature before placing dependants in contact with hot water, see "Warning About Hot Water" on page 4.

Transferring Priority

To control the water delivery temperatures when using two or more water controllers it is necessary to have priority transferred to the water controller you wish to use. Transferring of priority will **NOT** be possible if the 'In Use' indicator is currently illuminated, as this indicates hot water is flowing and that another water controller already has priority.

An illuminated Priority indicator confirms that the desired water controller is in control of the water delivery temperature. If the Priority indicator is not illuminated press the Priority Transfer button once. The Priority indicator will illuminate, indicating that hot water temperature control has been transferred and that the hot water unit will be ready to supply hot water once a hot water tap is opened.

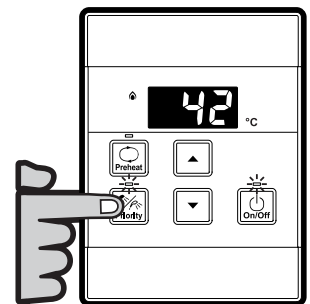

Water Controller Combinations & Configurations

Wireless, Universal and Deluxe water controllers can be combined, Refer to "Water Controller Combinations & Configurations" on page 9 to confirm the maximum number and combination of controllers that can be fitted.

SMARTSTART PRE-HEAT SYSTEM

The “Preheat” function works in conjunction with various Rinnai water heater models when the separately installed and optional Rinnai “Smartstart®” module is installed.

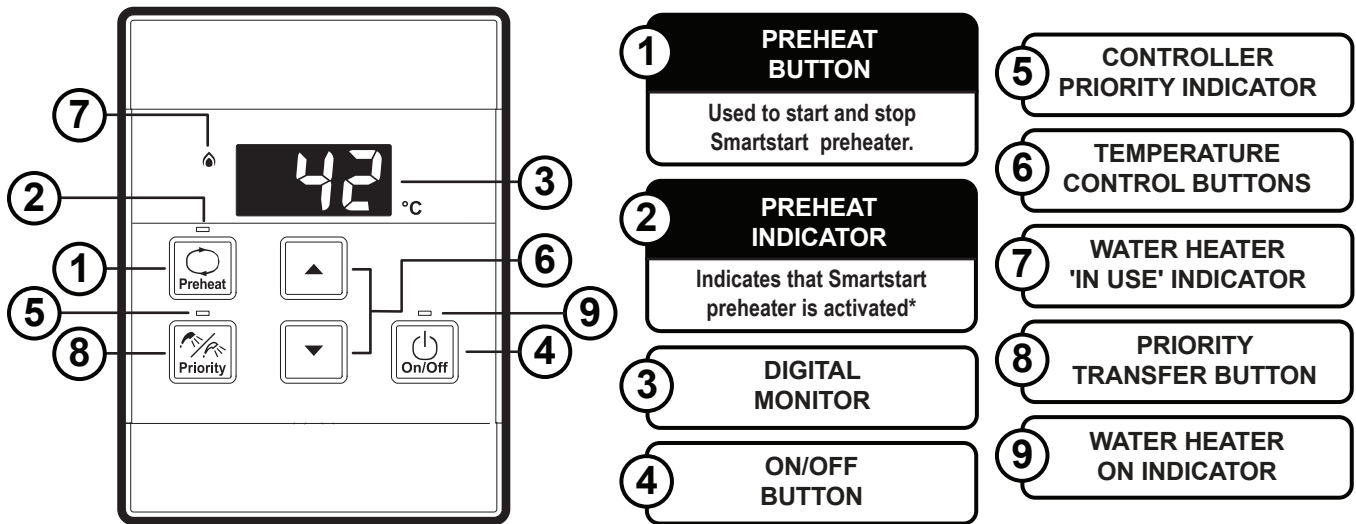

Preheat Function

When the “Preheat” function is activated and used in accordance with these instructions, water in the pipework connected between the water heater and the hot water outlets in your house is warmed before any outlets are opened. This results in water savings and added convenience.

Preheat Operation

1. Ensure that the hot water unit is on (temperature digits are displayed in the digital monitor ③). If more than one water controller is fitted press the ‘Priority Transfer’ button ⑧ to pass on priority to your desired water controller. The ‘Controller Priority’ indicator ⑤ will illuminate to confirm that priority has been assigned to this water controller and that the hot water unit is ready to deliver hot water.
2. Select the desired temperature using the ‘Temperature Control’ buttons ⑥ until the required temperature is displayed in the digital monitor ③.
3. Press the ‘Preheat’ button ① once. The ‘Preheat’ indicator ② and the ‘In Use’ indicator ⑦ will illuminate, signifying that the preheat system has been activated.
4. Wait approximately two minutes before opening an outlet. This will allow the water in the pipework to be warmed.



NOTE The waiting time may be longer or shorter than two minutes depending on your particular installation configuration.

The preheat function is cancelled 5 minutes after activation and the ‘Preheat’ indicator will go out. This is to conserve energy. To reactivate, simply repeat steps 2-4 above.

* If the ‘Preheat’ button is pressed and the ‘Smartstart’ preheat unit is not installed, the ‘Preheat’ indicator will still light but there will be no preheat function. The ‘Preheat’ indicator will go out after a short time and will not affect the other functions of the water controller or water heater.

After using the Shower Saver / Bath Fill function wait 30 seconds before activating the “Preheat” function. Attempting to use the “Preheat” function earlier will result in voice prompts being repeated until the system is reset. The system can be reset by pressing the ‘On /Off’ button twice.

Water Controller Functions

Water controller functions such as temperature control and transfer of priority between multiple controllers are not affected by the operation of the preheat. Such functions are described in the applicable sections of this manual.

TROUBLE SHOOTING

ERROR CODES

Your Rinnai Continuous Flow water heaters has a self diagnostic capability. If a fault occurs, an Error Code will flash on the digital monitor of your water controllers or on the status monitor * on the front cover of the water heater. This assists with diagnosing the fault, and may enable you to overcome a problem without a service call. Please quote the code displayed when enquiring about service.

*All models in the range covered by this manual have a "Status Monitor", except B16,B20 & B26.

Code	Description	Remedy
-	Noticeable reduction in water flow.	Inlet water filter needs to be cleaned - Service call.
03	Power interruption during Bath fill (Water will not flow on power reinstatement)	Turn off all hot water taps. Press On/Off twice.
10	Air intake or flue blocked.	Service Call.
11	No ignition / No gas supply.	Check gas is turned on at water heater and gas meter or cylinder.
12	Flame Failure / Low gas flow.	Check gas is turned on at water heater and gas meter or cylinder. Check there are no obstructions to the flue outlet.
14	Remaining Flame Safety Device.	Service Call.
16	Over Temperature Warning.	Service Call.
19	Electrical Earth Check Fault.	Service Call.
21	Incorrect Dipswitch Setting Detected	Installer to check Dipswitch Settings / Service Call.
32	Outgoing Water Temperature Sensor Fault.	Service Call.
41	Ambient Temperature Sensor Fault.	Service Call.
52	Gas Modulating Valve Fault.	Service Call.
61	Combustion Fan Fault.	Service Call.
65	Water Flow Control Fault (Does not stop flow properly).	Service Call.
70	Microprocessor Fault.	Service Call.
71	Microprocessor Fault.	Service Call.
72	Microprocessor Fault.	Service Call.
	Wireless water controller (when fitted) is 'Out of Range' due to the distance from transceiver or an obstruction.	Move wireless water controller or transceiver or remove the obstruction.

In all cases, you may be able to clear the Error Code simply by turning the hot water tap OFF, then ON again. If this does not clear the Error Code, try pushing the On/Off button OFF, then ON again, or turning the power for unit OFF, waiting 10 seconds and then ON again.

If the Error Code still remains, contact Rinnai for advice.

No power display Wireless Water Controller (when fitted)

When power to the water heater is disconnected the LCD of all wireless water controllers will display as shown to the right.

Check that the power is available, and that the water heater is plugged in with the power point turned 'on'.

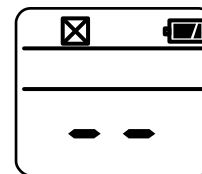

Troubleshooting Without Water Controllers

If you have no water controllers and experience the following symptoms, carry out these suggestions. If the symptom continues, contact Rinnai for advice.

Description	Remedy
The unit does not attempt to start at all.	Check the power is on at the unit. Check the isolation valves at the unit are open.
The unit starts then shuts down immediately.	Check the power is still on. Check the gas isolation valves at the unit and the gas meter are fully open. Open your hot water tap fully.
The unit starts then the water goes cold.	Check the power is still on. Open your hot water tap further.



Faults caused by insufficient gas supply, insufficient water supply, gas quality, water quality, installation errors or operation errors are **NOT covered by the Rinnai warranty. Refer to separate warranty booklet for details.**

SERVICE

Wired and wireless water controllers, transceivers and water heaters do not contain user serviceable parts and must only be serviced and repaired by an authorised person.

Rinnai has a Service and Spare Parts network with personnel who are fully trained and equipped to give the best service on your Rinnai appliance. If your appliance requires service, please call our National Help Line or the Hot Water Service Line (contact numbers for which are on the back cover of this manual).



When making a service enquiry, having both the model and serial numbers available, will help our staff quickly identify your appliance and better attend to your needs.

This information should have been copied to the "Installation Record" on page 25 by your installer, however if this is not the case, the information can also be found on the data plate located on the left hand side of the appliance.

Rinnai recommends that this appliance be serviced every 3 years.

INSTALLATION TABLE OF CONTENTS

Operation Table of Contents	3
General Installation Information	15
Regulations	15
Applicable Models	15
Appliance Location	15
Mounting Of Appliance	15
Service Connection Points	16
Pipe Sizing	16
Water Supply	16
Hot Water Delivery Temperature	17
Installation Configurations	17
Flueing	18
Appliance Flue Terminal	18
Horizontal Obstructions	19
Sideways Flue Diverter	19
Multiple Appliance Installations	19
Water Controller Installation	20
General Information	20
Master / Sub Water Controllers & Associated Temperatures	20
Water Controllers Limitations	20
Location	21
Communication Cables	21
Communication Cable(s) & 'Ezi connect'	22
Universal Water Controller (MC-601Q) Installation	22
Additional Programming & Activation Requirements	23
Commissioning	24
Testing	24
Delivery Temperature	24
50°C Compliant Models	24
For All Other Models	24
Gas Pressure Setting	25
Wiring Diagram	25
Commissioning Check List	25
Installation Record	25
Specifications	26
Table 1. Appliance Dimensions	26
Diagram 1. Dimensions	26
Table 2. Supply, Flow rates, Weights & Flow & Service Connections	27
Table 3. Maximum Delivery Temperatures	27
Table 4. Other Accessories	27
Contacts	28

GENERAL INSTALLATION INFORMATION



INSTALLATION, SERVICE AND REMOVAL MUST BE BY AN AUTHORISED PERSON ONLY.

It is the installer's responsibility to ensure all current AS/NZS 5601 requirements are met.

Remove transit protection. Check for damage, if any is found **DO NOT** install and contact supplier.

REGULATIONS

This appliance must be installed in accordance with:

- Current AS/NZS 3000, AS/NZS 3500 and AS/NZS 5601
- Rinnai Installation Instructions
- Local regulations and municipal building codes including local OH&S requirements

APPLICABLE MODELS

These Installation Instructions apply only to the Rinnai Continuous Flow Water Heater models that are listed on the cover page of this manual.

APPLIANCE LOCATION

This appliance is designed for 'Outdoor' Installation only. As such, it **MUST BE** located in an above ground open air situation with natural ventilation, without stagnant areas, where gas leakage and products of combustion are rapidly dispersed by wind and natural convection.

This appliance **MUST BE** mounted on a vertical structure with the water and gas connections on the underside pointing downwards. For appliances installed on elevated structures or under floors specific requirements apply. Refer to AS/NZS 5601 Section 6 for details.

Location of the appliance flue terminal **MUST BE** in accordance with Section 6 and Figure 6.2 of AS/NZS 5601. An extract (in part) has been reproduced in the "Appliance Flue Terminal" section of these instructions on page 18.

This appliance **MUST BE** placed as close as practicable to the most frequently used hot water outlet or outlets to minimise the delay time for hot water delivery. For installations where the distance between the water heater and the outlets is considerable, a flow and return system or the Rinnai Smartstart® system can be used which minimise the waiting time for hot water delivery.

Alternatively, multiple appliances can be strategically placed to serve outlets with minimal delay time. Contact Rinnai for further information.

An AC 230V/10 Amp, earthed power point **MUST BE** provided adjacent to the appliance. For outdoor installations this power point **MUST BE** weather proof. It **MUST BE** clear of the gas and water connections to the appliance and also the flue exhaust and water pressure relief valve. The power cord of the appliance is 1.5 Metres long.

All appliances **MUST BE** installed to ensure access can be gained without hazard or undue difficulty for inspection, repair, renewal or operational purposes. Sufficient clearances shall allow access to, and removal of, all serviceable components. Appliances should not be mounted higher than 2.5 metres above the ground or floor level unless the customer can arrange permanent and safe access or can provide another means of access, for example, by means of scissor or boom lifts acceptable to local authorities.

This appliance **MUST NOT** be used as a domestic spa or swimming pool heater.

Mounting Of Appliance

The wall or structure on which the units are to be mounted **MUST BE** capable of supporting these weights and the associated pipe-work. Refer to "Table 2. Supply, Flow rates, Weights & Flow & Service Connections" on page 27 for specific model weights.

Ensure that suitable fixing screws or bolts are used to secure the units to the wall, in accordance with AS/NZS 5601 section 6. Wooden plugs shall not be used.

The top bracket has a keyhole slot so that the appliance can be positioned by hanging it on one screw, once in position the appliance can then be fully secured with the application of further appropriate fittings.

The appliance can be mounted directly against the wall or structure. There is no need to use, non combustible sheeting or leave an air gap between the appliance back panel and the wall or structure to meet the temperature hazard requirements of AS/NZS 5601.

Service Connection Points

Refer to "Table 2. Supply, Flow rates, Weights & Flow & Service Connections" on page 27 for model specific connection / fitting dimension details.

An Approved full flow isolation valve and disconnection union **MUST BE** fitted to the cold water and gas inlets. A non return valve is not required on the water inlet unless required by local regulations.

Isolation Valves **MUST NOT** be fitted directly to the appliance.

If may be necessary to fit a temperature limiting device for delivery to areas used primarily for the purposes of personal hygiene. Refer to "Hot Water Delivery Temperature" on page 17.

Purge gas and cold water supply lines to remove air and swarf before final connection of the appliance. Swarf in either the gas or water supplies may cause damage.

Pipe Sizing

If the gas pipe sizing is insufficient the customer will not get the full performance benefit. Gas pipe sizing **MUST** consider the gas input to this appliance as well as all the other gas appliances in the premises. The gas meter and regulator **MUST BE** specified for this gas rate.

An approved sizing chart such as the one in AS/NZS 5601 should be used. Refer to "Table 2. Supply, Flow rates, Weights & Flow & Service Connections" on page 27 for model specific gas consumption details.

Water pipe sizing and layout should be performed in accordance with AS/NZS 3500. All hot water pipe-work should be insulated to optimise performance and energy efficiency.

Water Supply

The appliance is intended to be permanently connected to the water mains.

Refer to "Table 2. Supply, Flow rates, Weights & Flow & Service Connections" on page 27 for model specific operational water pressure limitations. Approved pressure limiting valves may be required if the 'Maximum' rated water supply pressures in Table 2 are exceeded. To achieve the rated flow, the 'Minimum' water supply pressures in Table 2 must be supplied.

The water heaters will operate at lower pressures but will not achieve the rated flow. Contact Rinnai for 'gravity fed' or 'low pressure' installations.

Water chemistry and impurity limits are detailed under 'Warranty Conditions'. Most metropolitan water supplies fall within the requirements.

If you are unsure about your local water quality, contact your water authority. If sludge or foreign matter is present in the water supply, a suitable filter or strainer is required in the water supply to the water heater to prevent unwarranted damage and loss of performance.

HOT WATER DELIVERY TEMPERATURE

Local regulations and or the requirements of AS/NZS 3500 **MUST BE** addressed regarding the temperature limitations of hot water supplied to areas used primarily for personal hygiene. The temperature of water to these areas may be limited to 50°C or less.

To ensure these regulations and or requirements are met the system **MUST BE** installed in accordance with the "Water Controller Combinations & Configurations" on page 9 and "Water Controllers Limitations" on page 20 of these instructions.

Installation Configurations

If the appliance is marked to state that it delivers water not exceeding 50°C, local regulations may permit installation without a Temperature Limiting Device. Installations without a Temperature Limiting Device are shown in Diagram 1 below. If you are unsure about your local regulations contact your regulating authority or Rinnai.

If the appliance is **NOT** marked to state that it delivers water not exceeding 50°C, or your local regulations require installation with a Temperature Limiting Device then install the appliance in accordance with Diagram 2 below.



If the appliance is to deliver water primarily for the purposes of personal hygiene in an early childhood centre, primary or secondary school, nursing home or a similar facility for the care of young, aged, sick or disabled persons as defined in AS/NZ 3500 a Temperature Limiting Device (TLD), such as a Tempering Valve may be required even if the appliance is set to 50° C or less.

For these types of applications contact Rinnai.

Diagram 1 : 50°C Appliance

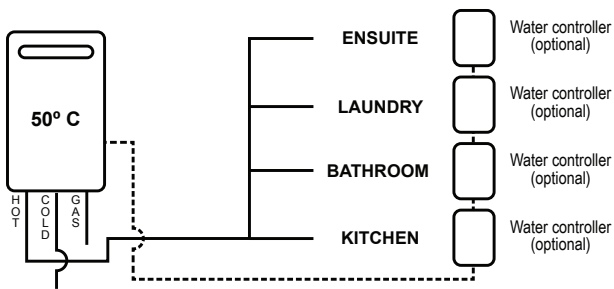
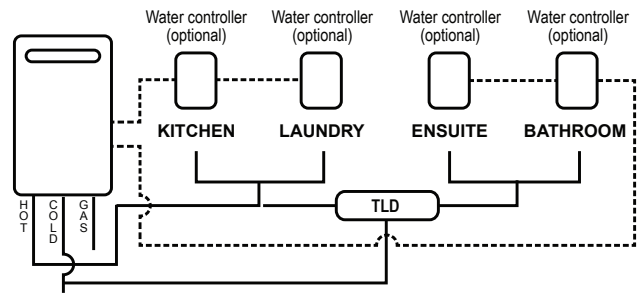

Diagram 2 : **NOT** a 50°C Appliance



Minimum length of pipe from hot outlet to nearest hot water tap 2 metres.



TLD = Temperature Limiting Device.

Universal water controllers are available as an optional extra and will function as described in the Operation Section of this manual. Refer to "Water Controller Combinations & Configurations" on page 9 and "Water Controllers Limitations" on page 20 to confirm the maximum number and combination of water controllers that can be fitted.

For detailed installation information of Universal water controllers refer to the "Water Controller Installation" chapter of this manual starting on page 20.

Operation and Installation information for Deluxe and Wireless water controllers is provided with the water controllers or visit www.rinnai.com.au.

FLUEING

APPLIANCE FLUE TERMINAL

Horizontal Terminal Clearances (Extract from AS/NZS 5601)

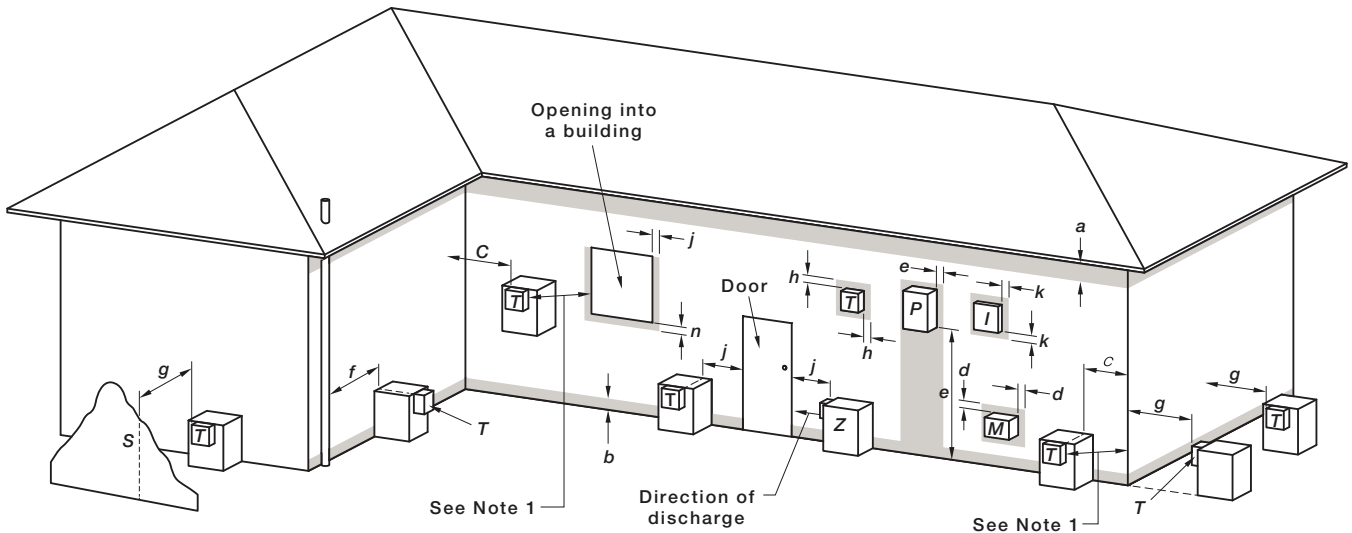

LEGEND:

I = Mechanical air inlet **M** = Gas meter **P** = Electricity meter or fuse box **Shading** indicates prohibited area for flue terminals
S = Structure **T** = Flue terminal **Z** = Fan-assisted appliance only

Ref.	Item	Min. Clearances (mm)
		Fan assisted
a	Below eaves, balconies and other projections: For appliances up to 50 MJ/h input	200
	For appliances over 50 MJ/h input	300
b	From the ground, above a balcony or other surface *	300
c	Front a return wall or external corner *	300
d	From a gas meter (M) (see Note 5) (see Clause 5.11.5.9 for vent terminal location of regulator) (see Table 6.7 for New Zealand requirements)	1000
e	From an electricity meter or fuse box (P) † (see Note 5)	500
f	From a drain pipe or soil pipe	75
g	Horizontally from any building structure* = or obstruction facing a terminal	500
h	From any other flue terminal, cowl, or combustion air intake *	300
j	Horizontally from an openable window, door, non-mechanical air inlet, or any other opening into a building with the exception of sub-floor ventilation: Appliances up to 150 MJ/h input *	300
	Appliances over 150 MJ/h input up to 200 MJ/h input *	300
	Appliances over 200 MJ/h input up to 250 MJ/h input *	500
	Appliances over 250 MJ/h input *	1500
	All fan-assisted flue appliances, in the direction of discharge	1500
k	From a mechanical air inlet, including a spa blower	1000
n	Vertically below an openable window, non-mechanical air inlet, or any other opening into a building with the exception of sub-floor ventilation: Space heaters up to 50 MJ/hr input	150
	Other appliances up to 50 MJ/hr input	500
	Appliances over 50 MJ/h input and up to 150 MJ/h input	1000
	Appliances over 150 MJ/h input	1500

* Unless appliance is certified for closer installation.

† Prohibited area below electricity meter or fuse box extends to ground level.

NOTES:

- Where dimensions c, j or k cannot be achieved an equivalent horizontal distance measured diagonally from the nearest discharge point of the terminal to the opening may be deemed by the Technical Regulator to comply.
- See Clause 6.9.4 for restrictions on a flue terminal under a covered area.
- See Figure J3 for clearances required from a flue terminal to an LP Gas cylinder. A flue terminal is considered to be a source of ignition.
- For minimum clearances not addressed above acceptance should be obtained from the Technical Regulator.
- Minimum clearances d and e also apply to any combustion air intake openings of appliances.

FIGURE 6.2 (in-part) LOCATION OF FLUE TERMINALS OF BALANCED FLUE, ROOM-SEALED, FAN-ASSISTED OR OUTDOOR APPLIANCES

Horizontal Obstructions

AS/NZS 5601 'Gas Installations' stipulates a minimum horizontal clearance of 500 mm between a building structure and obstruction facing the terminal.

For correct operation of Rinnai external continuous flow water heaters such a building structure **MUST** 'obstruct' the full front cover height of the appliance (for appliance dimensions, refer to "Table 1. Appliance Dimensions" on page 26), or extend vertically above and below the front cover as shown below.

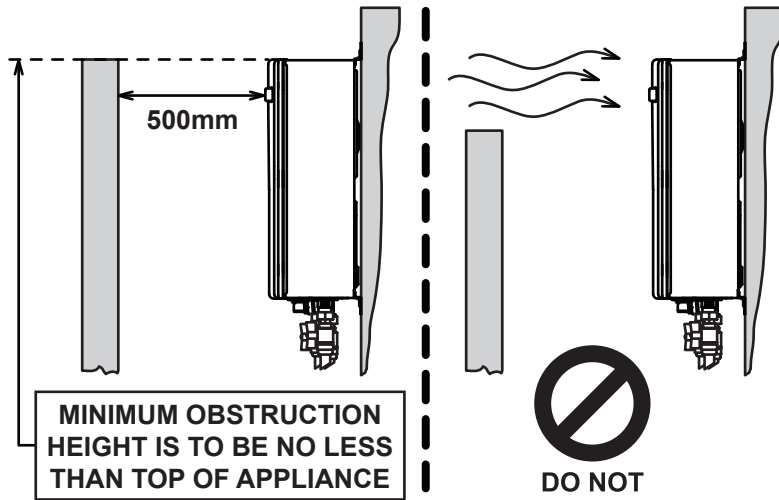

There **MUST** be **NO** partial obstructions to the front cover of the appliance or any other parts of the appliance casing. This will avoid the appliance failing to operate under windy conditions.

Sideways Flue Diverter

When a Sideways Flue Diverter is to be fitted the installer **MUST** also refer to the instructions provided with the Sideways Flue Diverter and observe all the specific clearances and warnings.



CONTROL BOARD DIPSWITCH SETTING:

The installer **MUST** follow the Sideways Flue Diverter instructions of the "Commissioning Check List" provided on the front cover of the appliance and the "Commissioning Instructions" located in the inside the appliance front cover.

When delivered ex-factory **ALL** the switches of the control board dipswitch are set to **OFF** (left position).

When a Sideways Flue Diverter is fitted the installer **MUST** set switches **SW1** and **SW3** to **ON** (right position) **ONLY**.

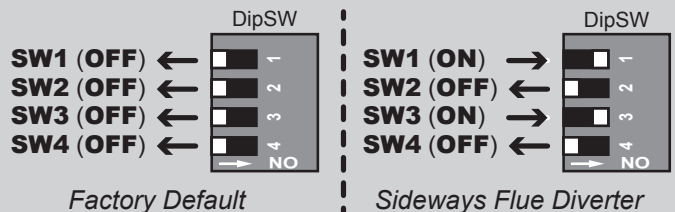

Improper setting of the switches will cause the appliance to operate incorrectly.

Multiple Appliance Installations

In reference to Horizontal Terminal Clearances (Extract from AS/NZS 5601) dimension 'h' on page 18 does not apply when multiple Rinnai external water heaters of the same model are installed on the same vertical face with flue terminals at the same height.

Under these conditions appliances can abut each other as shown above.

The total gas consumption of all appliances applies when determining other clearances.

For appliance dimensions, refer to "Table 1. Appliance Dimensions" on page 26.

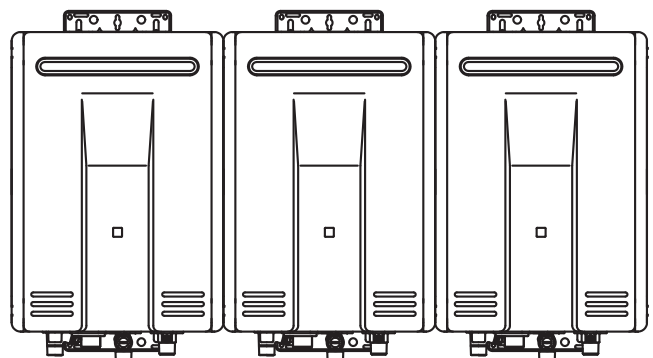

WATER CONTROLLER INSTALLATION

GENERAL INFORMATION



Other manufacturers water controllers are **NOT** compatible with Rinnai water heaters. Water controllers **MUST NOT** be used with any Solar Boost water heater. Rinnai water controllers brought in from other countries are not compatible with Rinnai appliances sold in Australia.

Regardless of water controller installation, all Rinnai water heaters must only be installed by an Authorised person.

Water controllers, transceivers and water heaters **DO NOT** contain user serviceable parts and must **ONLY** be serviced and repaired by an authorised person.

Master / Sub Water Controllers & Associated Temperatures

Only one MC model water controller can be designated as the 'Master' water controller. This water controller is normally used in the kitchen and usually has a maximum temperature of 55°C, which is sufficient for almost all kitchen applications. Temperatures higher than 55°C are possible but usually unnecessary and will result in higher gas use and increase the risk of burns.

Some additional conditions regarding Master Controller maximum temperatures apply when a wireless water controller is used as the 'Master' water controller.

- (i) Temperatures of 55°C or higher can only be selected on the controller designated as the 'Master' water controller if the transceiver 'Max Temp' is also programmed to 55°C or higher.
- (ii) The temperature of hot water delivered is always limited to the maximum temperature programmed into the water heater itself. For example, if the transceiver maximum temperature is programmed to 55°C and the water heater is limited to 50°C, the maximum temperature that the water heater will deliver is 50°C. In this case 55°C will be displayed on the wireless Master Controller until a tap is opened after which the display will revert to 50°C.



The water heater maximum temperature cannot be adjusted by the user. These adjustments can **ONLY** be carried out by a qualified and licensed trades person.

The remaining water controllers are designated 'sub' controllers and are for use in bathrooms, toilets and laundries. The temperature limit for all 'Sub' controllers is always 50°C to minimise the risk of burns in these areas.

Adhesive labels are included for individual identification of wireless water controllers as master (Kitchen) or sub (Bathroom) water controllers. These labels are usually placed on the top back of the wireless water controller body.

Water Controllers Limitations

An installation can have up to 4 universal MC-601Q water controllers.

Deluxe kitchen, bathroom and wireless water controllers are also available and various combinations of universal and the deluxe and wireless water controllers can be used with the following limitations:

- A maximum of 4 water controllers can be fitted.
- Only **ONE** master controller can be installed. This can be a deluxe kitchen, wireless or a universal (when programmed as a master controller) water controller.



When a deluxe kitchen is fitted it will always function as a master controller, this is the default setting and can not be changed.

- Up to **TWO** deluxe bathroom water controllers can be installed.
- The **FOURTH** water controller in any installation **MUST BE** a wireless or a universal water controller.

For more information regarding deluxe kitchen, bathroom and wireless water controllers, contact Rinnai or visit: www.rinnai.com.au.

Location



- **DO NOT** install water controllers near a heat source, such as a cook top, stove or oven. Heat, steam, smoke and hot oil may cause damage.
- **DO NOT** install water controllers outdoors unless protection from water / dust ingress and sunlight are provided.
- The water controller set as the **MASTER** water controller **MUST NOT** be installed in a bathroom.
- **DO NOT** install water controllers in direct sunlight.
- **DO NOT** install water controllers against a metal wall unless the wall is earthed in accordance with AN/NZS 3000.
- Water controllers **MUST NOT** be installed where chemicals such as benzene, alcohol, turpentine, hydrogen sulphide, ammonia, chlorine or other similar chemicals are in use.

The Water controller is a water resistant device, however excessive exposure to water may result in damage to the water controller. Durability is improved when positioned outside the shower recess.

- **AVOID** direct exposure to water or steam as these conditions may cause a malfunction.
- Water controllers must be installed in shaded and clean locations. They should be fitted out of reach of children (suggested height from floor to be at least 1500 mm). Water controllers **MUST BE** installed at least 400 mm above the highest part of a sink, basin or bath.
- When cleaning your water controller use **ONLY** a damp cloth and a mild detergent.

For water controller dimensions refer to "Table 1. Appliance Dimensions" and "Diagram 1. Dimensions" on page 26.

Communication Cables

Wired water controllers operate at an extra low voltage (12 Volts DC) which is supplied from the water heater, a 10 metre long communications cable is supplied for connection to the water heater. **ONLY** Rinnai supplied communication cables may be used. Optional longer communication cabling is available from Rinnai.

The water heater end of the cables are fitted with spade terminals. Only two pairs of cables (4 spade connectors in total) may be terminated. When attaching three or four cables it is necessary to join the cable terminals as follows:

For each pair cut off the existing spade connectors and re-terminate each pair into a new spade connector (A) (spade connectors are available from your local electrical component retailer) so that there are only two sets of spade connectors (4 spade connectors in total) to be terminated.

Single cables can be used when terminating up to two communication cables.

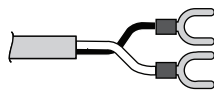

Paired cables are to be used when terminating three or four communication cables.

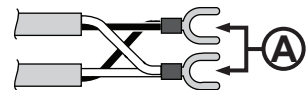

Connecting One or Two Communication Cables

Follow steps 1 through 5 of "Communication Cable(s) & 'Ezi connect'" on page 22 to terminate the cables to the water heater.

Connecting Three or Four Communication Cables

To connect three or four cables, separate all the cables to be fitted into pairs.

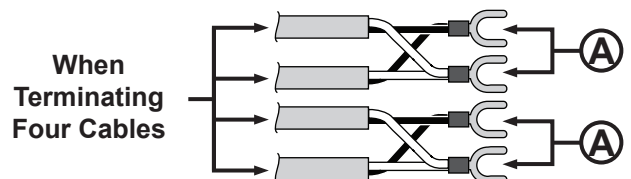
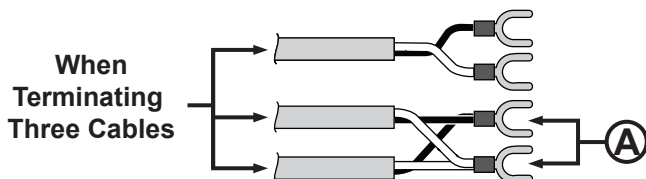

Follow steps 1 through 5 of "Communication Cable(s) & 'Ezi connect'" on page 22 to terminate the joined cable pairs to the water heater.

Communication Cable(s) & 'Ezi connect'



DO NOT attempt to connect cables to the 'Ezi connect' cable connector at the water heater unless the electric power to the water heater is switched 'off' otherwise damage to electrical components may occur.

If your water heater is not fitted with an 'Ezi connect' cable connector, installation must be completed by a qualified and licensed trades person.

1. Isolate the electric power supply by switching the power point off and removing the power plug of the water heater from the electric power socket.
2. Remove the retaining screw **A** of the 'Ezi connect' cable connector at the base of the appliance.
3. Swing the 'Ezi connect' cable connector door open and thread the cable through the weather seal of the cable access hole **B** in the direction shown allowing sufficient cable length so that the sheath of the cable can be secured with cable clamp **C**.
4. Loosen screw terminals **D** & **E** and connect the cable spade connectors to these terminals and re-tighten.
Polarity is not important, either wire colour can be connected to either terminal.
5. Return the 'Ezi connect' cable connector to the original position taking care not to damage cable wires in the process and replace the retaining screw **A**.

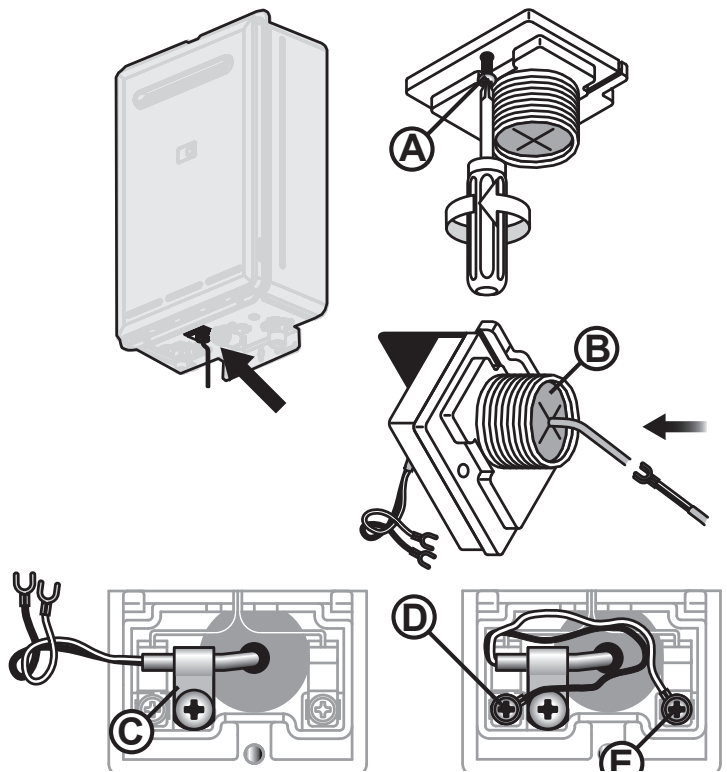

UNIVERSAL WATER CONTROLLER (MC-601Q) INSTALLATION

1. Determine the most suitable position, refer "Location" on page 21.
2. Mark and drill 3 holes (mounting and cable access) refer to "Table 1. Appliance Dimensions" and "Diagram 1. Dimensions" on page 26 for water controller dimensions.

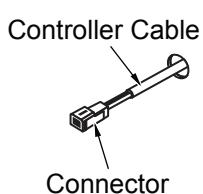

Fig. 1

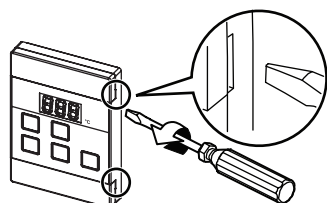

Fig. 2

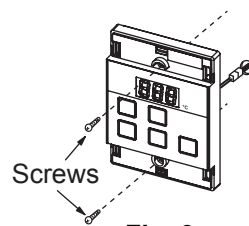

Fig. 3

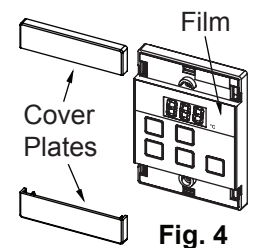

Fig. 4

3. When running cable through the access hole ensure the connector end of the cable is located nearest to the water controller (Fig. 1).
4. Carefully remove the cover plates from the water controller, using a screw driver (Fig. 2).
5. Connect the cable to the water controller. Feed any excess cable lengths into the wall cavity to avoid the pinching of cables between the wall and the water controller.
6. Fix the water controller to the wall using the appropriate fixings (Fig. 3).
7. Remove protective film from the water controller face and replace the cover plates (Fig. 4).

Additional Programming & Activation Requirements



1 Are there four water controllers connected?

IF NO: You have three (or fewer) water controllers, go to Question 2.

IF YES: You will need to activate the fourth water controller as follows:

STEP 1: For the water controller in the KITCHEN ONLY, press and hold the 'Priority Transfer' and 'On/Off' buttons simultaneously (see Fig. 1) until a 'beep' is heard (approximately 5 seconds).

STEP 2: Check that the display on ALL FOUR water controllers is lit and displaying a temperature when 'switched on'. If any ONE of the water controller displays two dashes (see Fig. 2) repeat STEP 1.

This completes the activation procedure for the fourth water controller, you may ignore Question 2.

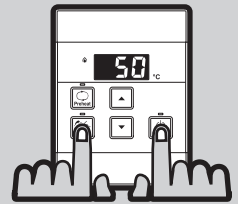

Fig. 1



Fig. 2



2 Is the water heater marked to state it delivers water not exceeding 50°C?

IF YES: No further action required..

IF NO: You will need to program the kitchen water controller to enable selection of temperatures higher than 50°C.

STEP 1: For the water controller in the KITCHEN ONLY, press and hold the 'Priority Transfer' and 'On/Off' buttons simultaneously (Fig. 3) until a 'beep' is heard (approximately 5 seconds).

STEP 2: When the water controller fitted in the KITCHEN is switched On, it should be possible to select temperatures higher than 50°C. If not, repeat STEP 1.

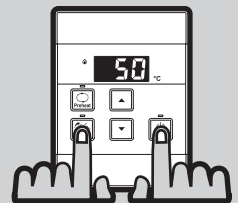

Fig. 3



If the water controller in the kitchen is replaced, repeat **STEP 1** for the replacement water controller.

If the water controller in the kitchen is swapped with another water controller (for example, the water controller fitted in a bathroom), repeat **STEP 1** for the water controller moved from the kitchen to the bathroom. Then perform **STEP 1** for the water controller moved from bathroom to the kitchen.

COMMISSIONING

TESTING

1. Before final connection of the water heater purge gas, hot water and cold water supply lines. Debris or swarf in either the gas or water supplies may cause damage.
2. Turn on gas and cold water supplies.
3. Test for water leaks and gas escapes near the unit.
4. Isolate gas supply. Remove test point screw located on the gas inlet connection and attach pressure gauge.



Confirm the control board dipswitch settings are set to the correct positions as required, i.e. factory default or with a Sideways Flue Diverter fitted, see "Sideways Flue Diverter" on page 19 for details.

5. Turn the power 'on' at the power point socket and turn on gas.
6. If water controllers are fitted, ensure they are 'ON', with the maximum delivery temperature selected and open **ALL** available hot water outlets.
If water controllers are not fitted, simply open **ALL** available hot water outlets.



Ensure building occupants **DO NOT** have access to hot water outlets during this procedure.

7. Operate **ALL** other gas appliances at their maximum gas rate, in accordance with manufacturers instructions.
8. With all gas appliances in operation at maximum gas rate, the pressure should read between 1.13 - 3.0 kPa on Natural Gas. On LPG the pressure should be 2.75 - 3.0 kPa. If the pressure is lower, the gas supply is inadequate and the appliance will not operate to specification. It is the Installers responsibility to check the gas meter, service regulator and pipe work for correct operation/sizing and rectify as required.



The gas regulator on the appliance is electronically controlled and factory pre-set. Under normal circumstances it **DOES NOT** need adjustment during installation.

9. Close hot water taps including the shower.
10. Inspect and clean the strainer located on the cold water inlet connection. This procedure may need to be repeated to ensure the strainer remains clear, especially on new installations.
11. If water controllers are fitted, it is necessary to test their operation through the complete range of functions (refer to the Operation sections of this manual).
12. Confirm the hot water delivery temperature(s) using a thermometer. If controllers are fitted, ensure temperatures exceeding 50°C cannot be selected on bathroom or ensuite controllers. Refer to the section 'Delivery Temperature' below for more details.
13. After testing is completed, explain to the householder the functions and operation of the water heater and water controllers (if fitted). Ensure the "Installation Record" on page 25 is filled in and that this booklet is handed to the customer. Reminding the customer to complete the Warranty Card and forward to Rinnai.

DELIVERY TEMPERATURE

50°C Compliant Models

"50°C Compliant" appliances are factory set to deliver a maximum temperature not exceeding 50°C. For fine tuning they have an incremental adjustment mechanism that allows the installer to increase the appliance delivery temperature incrementally from the 'Factory Set' value to temperatures slightly exceeding 50°C. This is intended to enable compensation for temperature losses in the pipe-work between the water heater and any outlets and achieve the required temperature at the outlet. Instructions for incremental temperature adjustment are located in the instruction pocket inside the appliance front cover.

For All Other Models

Rinnai continuous flow water heaters are factory pre-set to various maximum delivery temperatures depending on model and their intended application. For the majority of applications, the factory pre-set temperature is appropriate. In the unlikely event it is not this setting can be increased or decreased by the installer. Instructions for changing the maximum delivery temperature are located in the instruction pocket inside the appliance front cover.

GAS PRESSURE SETTING

The regulator is electronically controlled and factory pre-set. Under normal circumstances it **DOES NOT** require adjustment during installation. Make adjustments **ONLY** if the unit is not operating correctly and all other possible causes for incorrect operation have been eliminated. Instructions for gas pressure setting are located in the instruction pocket inside the appliance front cover.



For all injector size and gas pressure values refer to the appliance data plate, located on the left hand side of the water heater.

WIRING DIAGRAM

The wiring diagram is located in the instruction pocket inside the appliance front cover.

COMMISSIONING CHECK LIST

A commissioning check list is provided on the appliance front cover to enable the installer to step through the correct commissioning procedure when installing a Rinnai Continuous Flow water heater.

The check list can also assist the installer to identify potential installation errors that may prevent the appliance from operating correctly.

INSTALLATION RECORD

The Installation Record is a reference for the end user, help line staff and service technicians. Ensuring that this information is available here will be helpful in the event that a service enquiry is required.

Installer Details

Installation Company Name: _____

Address: _____

Telephone / Mobile Phone: _____ / _____

Email: _____

Certificate of Compliance / Certification No.: _____

Authorised Persons - Licence No.: _____

Installers Name: _____

Installers Signature: _____

Installation Date: _____

System Details

Water Heater - Model Number *: **REU-** _____

Water Heater - Serial Number *: _____

** This information will need to be copied from the data plate, located on the left hand side of appliance.*

Installation Address: _____

SPECIFICATIONS

TABLE 1. APPLIANCE DIMENSIONS

Use this table in conjunction with "Diagram 1. Dimensions" below. All dimensions in mm unless otherwise stated.		Model								
		REU-AM1220WD <i>Infinity 12</i>	REU-AM1620WD <i>Infinity 16</i>	REU-AM2024WD <i>Infinity 20</i>	REU-AM2626WD <i>Infinity 26</i>	REU-AM2626WDL <i>Infinity 26 Touch</i>	REU-A1620WB <i>B16</i>	REU-A2024WB <i>B20</i>	REU-A2626WB <i>B26</i>	MC-601Q <i>Universal</i>
A	Width	356	356	356	356	356	351	351	351	90
B	Depth	202	202	202	202	202	195	195	195	21
C	Height Unit	503	503	503	503	503	531	531	531	120
D	Height Including Brackets	571	571	571	571	571	571	571	571	-
E	Hot Water outlet (from wall)	87	87	87	87	87	87	87	87	-
F	Hot Water outlet (from centre)	105	105	105	105	105	105	105	105	-
G	Cold Water inlet (from wall)	68	68	68	68	68	68	68	68	-
H	Cold Water inlet (from centre)	10	10	10	10	10	10	10	10	-
I	Gas Connection from wall)	77	77	77	77	77	77	77	77	-
J	Gas Connection (from centre)	83	83	83	83	83	83	83	83	-
K	Gas Connection Length (from base)	40	40	40	40	40	40	40	40	-
	Cold Connection Length (from base)	50	50	50	50	50	50	50	50	-
	Hot Connection Length (from base)	39	39	41	41	41	39	41	41	-
L	Vertical Mounting Hole Centres	-	-	-	-	-	-	-	-	84
M	Cable Access Hole Size	-	-	-	-	-	-	-	-	Ø20
	Position	-	-	-	-	-	-	-	-	Centre

DIAGRAM 1. DIMENSIONS

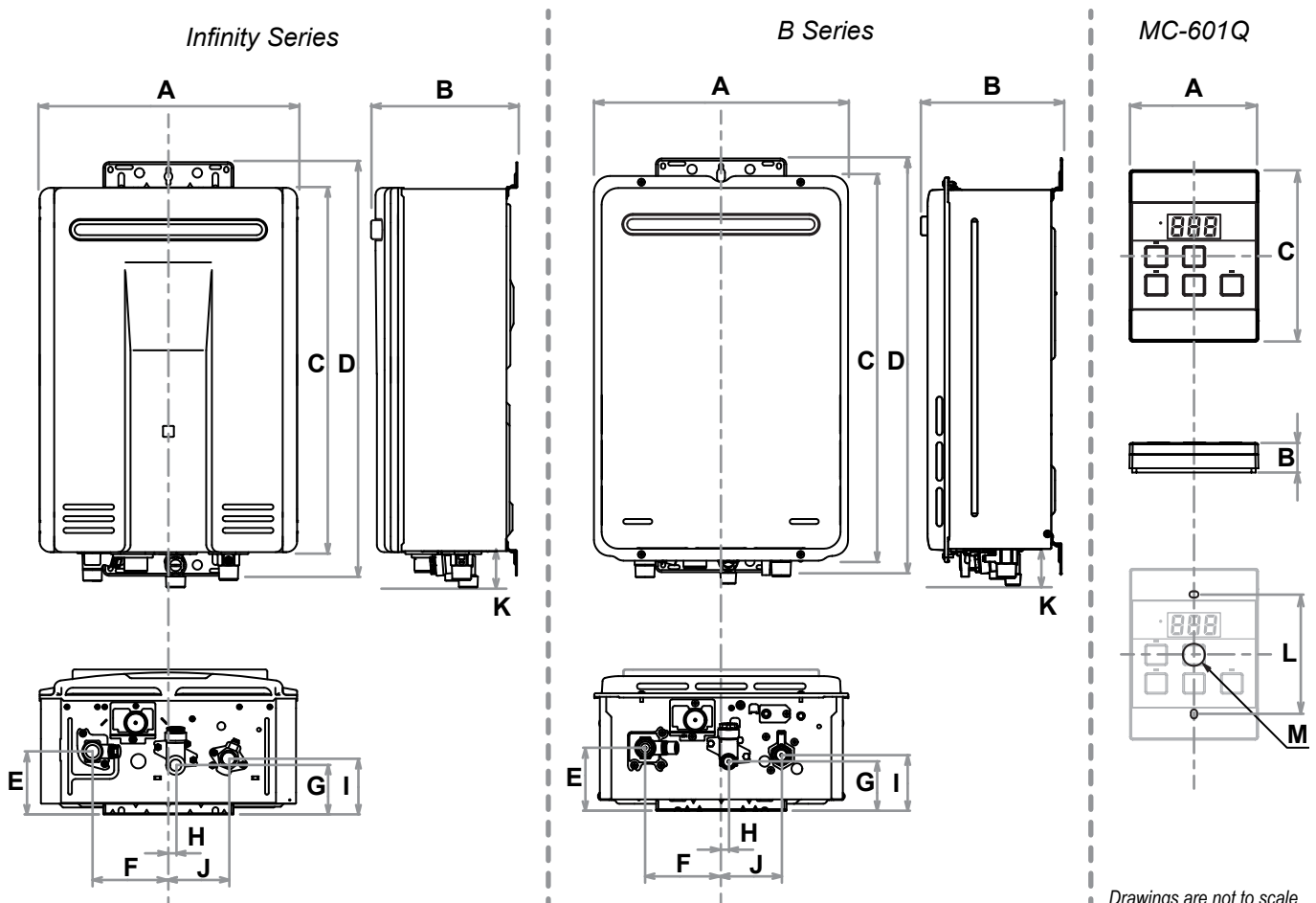

Drawings are not to scale

TABLE 2. SUPPLY, FLOW RATES, WEIGHTS & FLOW & SERVICE CONNECTIONS

Model	Gas Rate	Water Supply Pressure		Max Flow at Temp Rise (at minimum water supply pressure)				Weight	Fittings		
		Min	Max						Hot	Cold	Gas
	MJ/hr	kPa		L/min / °C				kg	(DN = mm)		
REU-AM1220WD - <i>Infinity 12</i>	92	120	1000	15 / 20	12 / 25	7.5 / 40	6 / 50	13.5	R ½ (15)	R ½ (15)	R ¾ (20)
REU-AM1620WD - <i>Infinity 16</i>	124	120	1000	20 / 20	16 / 25	10 / 40	8 / 50	13.5	R ½ (15)	R ½ (15)	R ¾ (20)
REU-AM2024WD - <i>Infinity 20</i>	156	160	1000	24 / 20	20 / 25	12.5 / 40	10 / 50	14.5	R ¾ (20)	R ¾ (20)	R ¾ (20)
REU-AM2626WD - <i>Infinity 26</i>	199	200	1000	26 / 20	26 / 25	16.3 / 40	13 / 50	15.5	R ¾ (20)	R ¾ (20)	R ¾ (20)
REU-AM2626WDL - <i>Infinity 26 Touch</i>	199	200	1000	26 / 20	26 / 25	16.3 / 40	13 / 50	15.5	R ¾ (20)	R ¾ (20)	R ¾ (20)
REU-A1620WB - <i>B16</i>	124	120	1000	20 / 20	16 / 25	10 / 40	8 / 50	13	R ½ (15)	R ½ (15)	R ¾ (20)
REU-A2024WB - <i>B20</i>	156	160	1000	24 / 20	20 / 25	12.5 / 40	10 / 50	14	R ¾ (20)	R ¾ (20)	R ¾ (20)
REU-A2626WB - <i>B26</i>	199	200	1000	26 / 20	26 / 25	16.3 / 40	13 / 50	15	R ¾ (20)	R ¾ (20)	R ¾ (20)

TABLE 3. MAXIMUM DELIVERY TEMPERATURES

- (a) Factory "Pre-Set" Maximum delivery temperature (°C)
- (b) Can the Factory "Pre-Set" Maximum delivery temperature be changed by an authorised person?

Delivery Temperature	Non - 50°C Compliant - Models								50°C Compliant - Models							
	REU-AM1220WD	REU-AM1620WD	REU-AM2024WD	REU-AM2626WD	REU-AM2626WDL	REU-A1620WB	REU-A2024WB	REU-A2626WB	REU-AM1220WD-50	REU-AM1620WD-50	REU-AM2024WD-50	REU-AM2626WD-50	REU-AM2626WDL-50	REU-A1620WB-50	REU-A2024WB-50	REU-A2626WB-50
(a)	60	60	60	60	60	60	60	60	50	50	50	50	50	50	50	50
(b)	Yes	Yes	Yes	Yes	Yes	Yes	Yes	Yes	No	No	No	No	No	No	No	No

TABLE 4. OTHER ACCESSORIES

Contact Rinnai for more information about our accessory range and model suitability, or visit: www.rinnai.com.au.

SMART BOX (plastic) RECESS BOX (metal)	Recess boxes are available in either plastic or metal, and are designed to permit a recessed installation of a Rinnai Continuous Flow water heater into a wall cavity, saving precious space. Recess boxes are also suitable for painting.
PIPE COVER	Pipe covers attach easily to a Rinnai Continuous Flow water heater and are designed to conceal pipes and valves. Pipe covers may also be joined to one another to conceal longer pipe work.
SECURITY CAGE	Protects the Rinnai Continuous Flow water heater from theft and damage.
SECURITY BRACKET	Prevent theft of your Rinnai Continuous Flow water heater by securing it with the custom security bracket.
SIDEWAYS FLUE DIVERTER	Designed to redirect flue products when a Rinnai Continuous Flow water heater is installed on a balcony.
WATER CONTROLLERS	An extended range of Deluxe Kitchen, Deluxe Bathroom and Wireless water controllers are also available.

Rinnai

Rinnai Australia Pty Ltd

ABN 74 005 138 769

100 Atlantic Drive, Keysborough,
Victoria 3173

P.O. Box 460,
Braeside, Victoria 3195

Tel: (03) 9271 6625
Fax: (03) 9271 6622

National Help Line

Tel: 1300 555 545*
Fax: 1300 555 655*

*Cost of a local call higher from mobile
or public phones.

Hot Water Service Line

Tel: 1800 000 340

For further information visit

www.rinnai.com.au

or email **enquiry@rinnai.com.au**

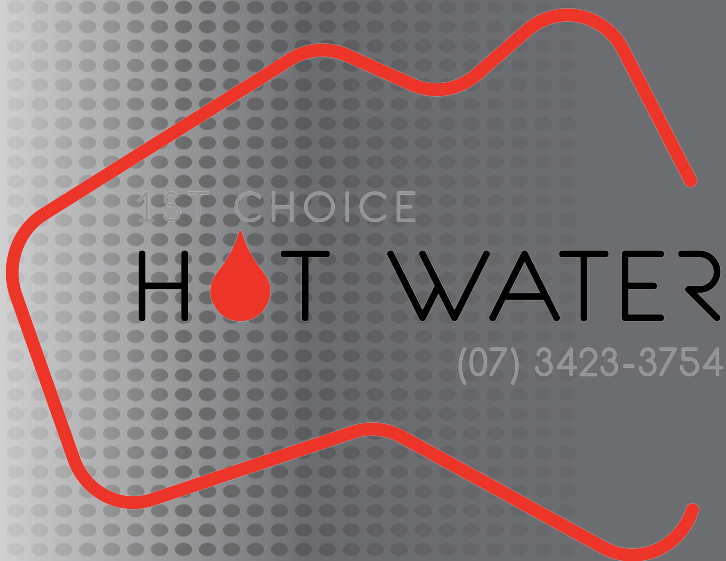

U340-1330(01)

Rinnai has a Service and Spare Parts network with personnel who are fully trained and equipped to give the best service on your Rinnai appliance. If your appliance requires service, please call our National Help Line. Rinnai recommends that this appliance be serviced every 3 years.