

OPERATION AND INSTALLATION

Fully electronically controlled comfort instantaneous water heater

- » DHE 18 AU
- » DHE 27 AU

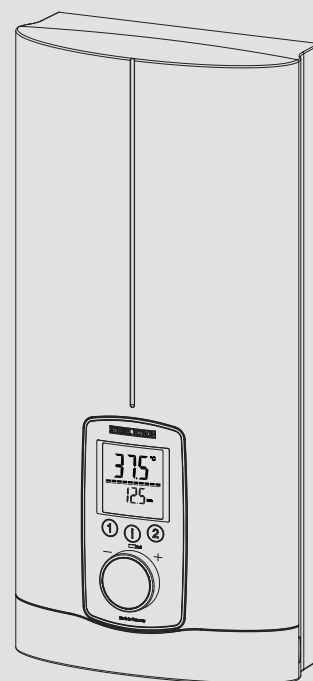

STIEBEL ELTRON

CONTENTS

SPECIAL INFORMATION

OPERATION

1. General information	4
1.1 Safety instructions	4
1.2 Other symbols in this documentation	4
1.3 Units of measurement	4
2. Safety	4
2.1 Intended use	4
2.2 General safety instructions	4
2.3 Test symbols	5
3. Appliance description	5
4. Settings and displays	5
4.1 User interface	5
4.2 Display symbols	6
4.3 Selecting the set temperature	6
4.4 Temperature limit via internal anti-scalding protection (qualified contractor)	6
4.5 Temperature limit Tmax (user)	6
4.6 Assigning temperature memory buttons	6
4.7 Inlet temperature information	6
4.8 Info menu	6
4.9 Settings in the parameter menu	6
4.10 Recommended settings	8
5. Cleaning, care and maintenance	8
6. Troubleshooting	9

INSTALLATION

7. Safety	9
7.1 General safety instructions	9
7.2 Shower operation	9
7.3 Instructions, standards and regulations	9
8. Appliance description	10
8.1 Standard delivery	10
8.2 Accessories	10
9. Preparation	10
9.1 Installation site	10
9.2 Minimum clearances	10
9.3 Water installation	10
10. Installation	11
10.1 Standard installation	11
11. Commissioning	13
11.1 Preparation	13
11.2 Initial start-up	13
11.3 Recommissioning	14
12. Appliance shutdown	14
13. Installation alternatives	14
13.1 Electrical connection from above on unfinished walls	14
13.2 Electrical connection on unfinished walls from below with short power cable	15
13.3 Electrical connection on finished walls	15
13.4 Water installation on unfinished walls	15
13.5 Wall mounting bracket when replacing an appliance	16
13.6 Installation with offset tiles	16
13.7 Rotated appliance cover	16

13.8 Operation with preheated water	16
13.9 Horizontal installation of the appliance	17
14. Service information	17
15. Troubleshooting	18
15.1 Fault code display	18
16. Maintenance	19
17. Specification	19
17.1 Dimensions and connections	19
17.2 Wiring diagram	20
17.3 DHW output	20
17.4 Application areas / conversion table	20
17.5 Pressure drop	20
17.6 Fault conditions	20
17.7 Data table	21

ENVIRONMENT AND RECYCLING

WARRANTY

SPECIAL INFORMATION

- The appliance may be used by children over 3 years of age and persons with reduced physical, sensory or mental capabilities or a lack of experience and expertise, provided that they are supervised or they have been instructed on how to use the appliance safely and have understood the potential risks. Children must never play with the appliance. Cleaning and user maintenance must not be carried out by children without supervision.
- If using preheated water, the fitting can reach a temperature of up to 70 °C during operation. There is a risk of scalding at outlet temperatures in excess of 43 °C.
- The appliance is suitable for supplying a shower (shower operation). If the appliance is also or exclusively used for shower operation, the qualified contractor must adjust the temperature setting range to 43 °C using the internal anti-scalding protection on the appliance. When using preheated water, ensure that the inlet temperature does not exceed 55 °C.
- In Australia, the use of a temperature controller is required to meet the requirements of AS 3498 when showers, bathtubs or washbasins are supplied with water. The maximum temperature of 50 °C must not be exceeded.
- Ensure the appliance can be separated from the power supply by an isolator that disconnects all poles with at least 3 mm contact separation.
- The specified voltage must match the power supply.
- The appliance must be connected to the earth conductor.
- The appliance must be permanently connected to fixed wiring.
- Secure the appliance as described in chapter "Installation / Installation".
- Observe the maximum permissible pressure (see chapter "Installation / Specification / Data table").
- The specific water resistivity of the mains water supply must not be undershot (see chapter "Installation / Specification / Data table").
- Drain the appliance as described in chapter "Installation / Maintenance / Draining the appliance".

OPERATION

1. General information

The chapters "Special information" and "Operation" are intended for both users and qualified contractors.

The chapter "Installation" is intended for qualified contractors.



Note

Read these instructions carefully before using the appliance and retain them for future reference. Pass on these instructions to a new user if required.

1.1 Safety instructions

1.1.1 Structure of safety instructions



KEYWORD Type of risk

Here, possible consequences are listed that may result from failure to observe the safety instructions.

► Steps to prevent the risk are listed.

1.1.2 Symbols, type of risk

Symbol	Type of risk
	Injury
	Electrocution
	Burns (burns, scalding)

1.1.3 Keywords

KEYWORD	Meaning
DANGER	Failure to observe this information will result in serious injury or death.
WARNING	Failure to observe this information may result in serious injury or death.
CAUTION	Failure to observe this information may result in non-serious or minor injury.

1.2 Other symbols in this documentation



Note

General information is identified by the adjacent symbol.

► Read these texts carefully.

Symbol	Meaning
	Material losses (appliance damage, consequential losses and environmental pollution)
	Appliance disposal

► This symbol indicates that you have to do something. The action you need to take is described step by step.

1.3 Units of measurement



Note

All measurements are given in mm unless otherwise stated.

2. Safety

2.1 Intended use

This appliance is suitable for heating domestic hot water or for reheating preheated water. The appliance can supply one or more draw-off points.

Water will not be reheated if the maximum inlet temperature for reheating is exceeded.

The appliance is intended for domestic use. It can be used safely by untrained persons. The appliance can also be used in non-domestic environments, e.g. in small businesses, as long as it is used in the same way.

Any other use beyond that described shall be deemed inappropriate. Observation of these instructions and of the instructions for any accessories used is also part of the correct use of this appliance.

2.2 General safety instructions



CAUTION Burns

If using preheated water, the fitting can reach a temperature of up to 70 °C during operation. There is a risk of scalding at outlet temperatures in excess of 43 °C.



CAUTION Burns

If operating with preheated water, e.g. from a solar thermal system, the DHW temperature may vary from the selected set temperature.

Appliance description



CAUTION Burns
 If children or persons with limited physical, sensory or mental capabilities use the appliance, set a temperature limit. Once set, check the temperature limit is working correctly.
 If a permanent and unchangeable temperature limit is required, have the internal anti-scalding protection set by a qualified contractor.



WARNING Injury
 The appliance may be used by children over 3 years of age and persons with reduced physical, sensory or mental capabilities or a lack of experience and expertise, provided that they are supervised or they have been instructed on how to use the appliance safely and have understood the potential risks. Children must never play with the appliance. Cleaning and user maintenance must not be carried out by children without supervision.



WARNING
 For continued safety of this appliance it must be installed, operated and maintained in accordance with the manufacturer's instructions.



WARNING
 This appliance may deliver water at high temperature. Refer to the plumbing code of Australia (PCA), local requirements and installation instructions to determine if additional delivery temperature control is required.



Material losses
 The user should protect the appliance and its tap against frost.

2.3 Test symbols

See type plate on the appliance.

3. Appliance description

The appliance switches on automatically as soon as you open the hot water valve on the tap. When you close the tap, the appliance switches off again automatically.

The appliance heats water as it flows through it. The set temperature is adjustable. Upwards of a certain flow rate, the control unit selects the required heating output, subject to the temperature selected and the cold water temperature.

The instantaneous water heater with full electronic control and automatic output matching maintains a consistent outlet temperature. The fully electronic control unit with motorised valve ensures the water is accurately heated to the selected temperature. This occurs regardless of the inlet temperature.

If the appliance is operated with preheated water and the inlet temperature exceeds the selected temperature, the inlet temperature is indicated on the second display line and flashes. The water is not heated further.

You can store different set temperatures and call them up quickly. In the ECO function, the integral motorised valve limits the flow rate to 3 preset levels. The appliance has setting options for a temperature limit (Tmax function, user) and internal anti-scalding protection (qualified contractor). The backlight switches on automatically as soon as water starts to flow through the appliance or you make a change on the user interface. The backlight switches off automatically after water stops flowing or if no action is performed.

Heating system

The bare wire heating system is enclosed within a pressure-tested plastic jacket. The heating system with its stainless steel heater spiral is suitable for hard and soft water areas and is largely insusceptible to scale build-up. The heating system ensures rapid and efficient DHW provision.



Note
 The appliance is equipped with an air detector that largely prevents damage to the heating system. If, during operation, air is drawn into the appliance, the appliance shuts down heating output for one minute to protect the heating system.

4. Settings and displays

4.1 User interface

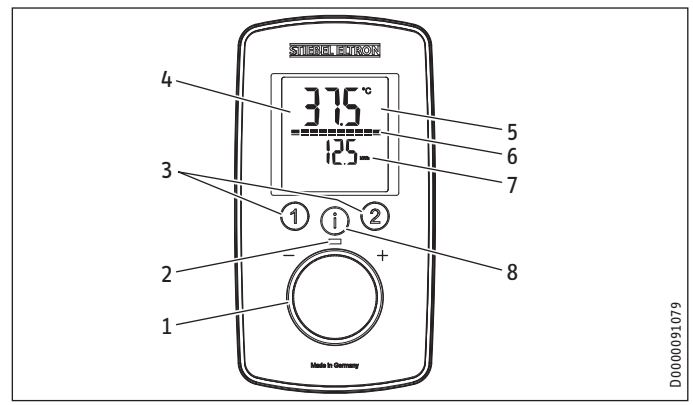

- 1 Selector
- 2 ON LED
- 3 Temperature memory keys
- 4 Backlit display
- 5 Main display | info display | parameter display
- 6 Segment display [10 - 100 %]
- 7 Second display line
- 8 "i" button to call up information and select menus

Settings and displays

4.2 Display symbols

The symbols are shown on the display when activated.

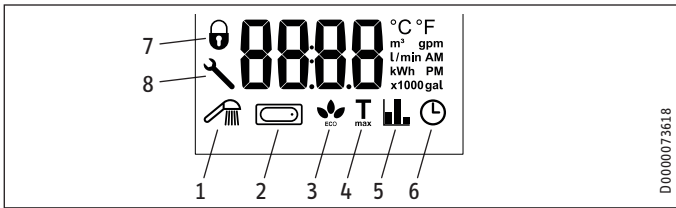

- 1 Wellness showers
- 2 Automatic water volume control
- 3 ECO display
- 4 Tmax, displayed when temperature limit is enabled
- 5 Consumption indicator
- 6 Time
- 7 Operating lock [ON / OFF]
- 8 Spanner symbol, appears in the event of a fault

4.3 Selecting the set temperature

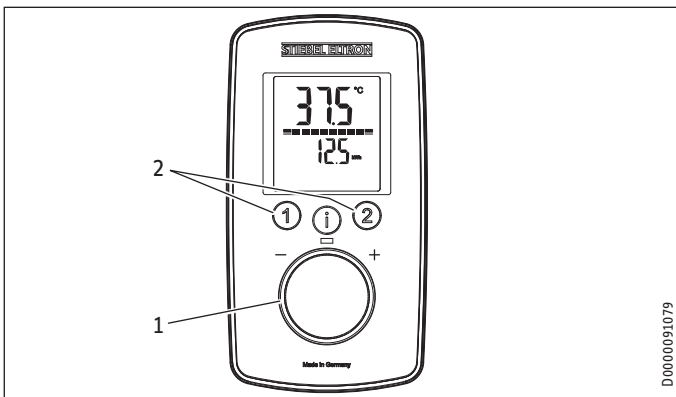

- 1 Set temperature settings: OFF, 20 - 60 °C
- 2 To call up/assign preferred temperatures

Settings			
Setting	Step	Setting	Step
20 °C ... 60 °C	0.5 °C	68 °F ... 140 °F	1 °F

4.4 Temperature limit via internal anti-scalding protection (qualified contractor)

If required, the qualified contractor can set a permanent temperature limit, for example in nurseries, hospitals, etc.

If the anti-scalding protection function is enabled and the temperature limit is reached, "Tmax" flashes.

4.5 Temperature limit Tmax (user)

You can adjust the temperature limit individually. If the temperature limit is enabled, "Tmax" is shown on the display.

4.5.1 Activating/deactivating the temperature limit Tmax

See chapter "Settings in the parameter menu".

4.6 Assigning temperature memory buttons

Memory buttons "1" and "2" can each be assigned a preferred temperature.

- ▶ Select the preferred temperature.
- ▶ To save the preferred temperature, press and hold button "1" or "2" for more than 3 seconds. The selected temperature flashes once to confirm.

4.7 Inlet temperature information

If the appliance is operated with preheated water and the inlet temperature exceeds the selected set temperature, the inlet temperature is indicated on the second display line and flashes. The water is not heated further.

4.8 Info menu

The appliance has an additional display where consumption values can be shown.

4.8.1 Calling up the info menu

- ▶ Briefly press "i" until "i 1" appears, then continue to press "i" to see further menus.
- ▶ Exit the menu item by pressing "i" and holding for more than 5 seconds. Alternatively: The system exits the menu item automatically 30 seconds after the setting has been completed.

Menu	Description	Explanations	Screen display
I 1	Flow rate	The current flow rate is shown.	Flow rate in l/min or gpm
I 2	Time	The current time is shown.	Time
I 3	Energy consumption	The amount of energy consumed is shown.	Value in kWh
I 4	Water consumption	The amount of water consumed is shown.	Value in m³ or gal



Note

The consumption values are calculated starting from the last reset.

4.9 Settings in the parameter menu







4.9.1 Activating the parameter menu

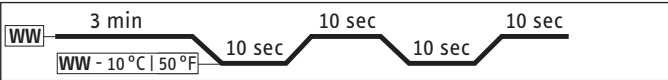
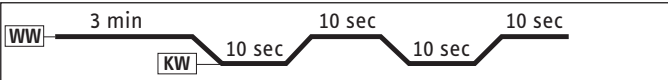
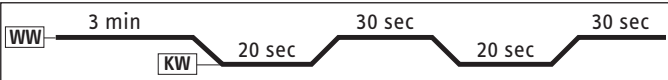

- ▶ Briefly press and hold "i" for more than 5 seconds until "P 1" appears, then continue by briefly pressing "i".
- ▶ In the selected parameter menu, turn the temperature selector to the required display / setting.

OPERATION

Settings and displays

4.9.2 Parameter menu

Menu	Description	Selectable display setting	Explanations	Symbol display
P 1	ECO water and energy saving function	OFF ECO1 ECO2 ECO3	The ECO function enables you to limit the flow rate to a maximum value. Flow rate limit: 8 l/min with "ECO1" 7 l/min with "ECO2" 6 l/min with "ECO3" No flow rate limit with "OFF".	
P 2	Temperature limit Tmax	OFF 20.0 20.5 ... °C or 68 69 ... °F	The temperature limit allows you as a user to restrict the adjustable set temperature at the appliance to a maximum value. Check that the upper temperature limit has been correctly applied. Your qualified contractor can set an additional temperature limit for anti-scalding protection. This temperature then dictates the upper limit of the setting range for the temperature limit function.	
P 3	Wellness showers	OFF Pro1 Pro2 Pro3 Pro4	The Wellness shower program lets you choose from 4 different alternating shower programs. WW = domestic hot water, KW = cold water, min = minutes, sec = seconds - 1 Cold prevention To strengthen the body, we recommend finishing off with a cold shower; this will trigger a reflex in the body to warm up.  - 2 Winter refreshment An invigorating end to a winter shower with a final warm-up.  - 3 Summer fitness program A quick contrast shower to increase fitness with a final warm-up.  - 4 Circulation boost program Shower your arms and legs with cold water to boost circulation. Spray from the hands and feet towards the body. You can then repeat this process with hot water. 	
P 4	Automatic water volume control - set the volume in the selected unit	OFF 5 10 ... 200 or 2 ... 52 gal	With the automatic water volume control, you can preselect a volume of water, e.g. for filling a bathtub. When the preselected water volume is reached, the automatic control reduces the flow rate. The automatic water volume control must be enabled on each occasion prior to filling the bath. Example, filling a bath with 80 litres (21 gallons): When the bath has been filled with 80 litres (21 gallons), the control automatically reduces the flow rate to 4 l/min (1 gpm).	
P 5	Temperature unit	C F	Select the temperature unit for all settings.	°C °F
P 6	Volume unit	L GAL	Select the volume unit for all settings.	l gal
P 7	Time format	24h 12h	Select time format.	
P 8	Time setting	--:--	You can set the time using the 12 or 24 hour clock: - 12 hours from 00:00 - 11:59 = AM 11:59 - 00:00 = PM - 24 hours from 00:00 to 23:59 After a power cut, the time needs to be set again.	AM PM (only for 12h)
P 9	Operating lock	ON OFF	You can set the operating lock to "ON" or "OFF". To disable the set operating lock: ▶ Press and hold "i" for more than 12 seconds.	 (only when ON)
P 10	Reset to factory settings	Reset (rSEt)	You can restore the appliance to its factory settings. "rSEt" is shown on the display. ▶ Press "1" and "2" simultaneously and hold for longer than 5 seconds. The display switches to "On" to confirm the reset. ▶ To confirm "On", press and hold "i" for more than 5 seconds.	

Menu	Description	Selectable display setting	Explanations	Symbol display
P 11	Resetting the consumption values	Reset (rSEt )	You can reset the consumption values. "rSEt" is shown on the display. ▶ Press "1" and "2" simultaneously and hold for longer than 5 seconds. The display switches to "On" to confirm the reset. ▶ To confirm "On", press and hold "i" for more than 5 seconds.	
P 12	Backlighting	Auto On	You can adjust the display backlight. - If "Auto" is selected, the backlight is switched on during heating operation and each time an action is performed. If no action is performed for 30 seconds, the backlight is switched off again. - If you select "On", the backlight will remain on constantly.	
P 13	Reduce backlighting	100 % 20 % ()	You can select 2 levels of brightness for the backlight.	
P 14	Wireless module		After installation of a wireless module (with or without paired wireless remote control) in the appliance, menu item P 14 is enabled and "rc" appears on the programming unit display. You can pair one or more wireless remote controls; to do so, follow the pairing procedure on the appliance and the wireless remote control. Pressing "1" on the appliance for longer than 5 seconds starts the pairing process, which is shown on the programming unit of the appliance by a progress bar on the display and the operating LED flashing. Start the pairing process on the wireless remote control as described in the relevant operating instructions. After successful pairing, the operating LED on the appliance flashes briefly. An unsuccessful pairing attempt is automatically terminated after 30 seconds. Pressing "2" on the appliance for longer than 5 seconds unpairs all connected wireless remote controls. During unpairing, "rc0" appears on the display of the programming unit for 5 seconds, then "rc" again.	

4.9.3 Deactivating the parameter menu

- ▶ Exit the menu item by pressing "i" and holding for more than 5 seconds. Alternatively: The system exits the menu item automatically 30 seconds after the setting has been completed.

4.10 Recommended settings

Your instantaneous water heater offers maximum precision and maximum convenience in DHW provision. Should you nonetheless operate the appliance with a thermostatic valve, we recommend that you:

- ▶ Adjust the set temperature on the appliance to over 50 °C. Then set the required set temperature on the thermostatic valve.

Saving energy

The following recommended settings will result in the lowest energy consumption:

- 38 °C for hand washbasins, showers, bath
- 55 °C for kitchen sinks

Internal anti-scalding protection (qualified contractors)

If required, the qualified contractor can set a permanent temperature limit, for example in nurseries, hospitals, etc.

Recommended setting for operation with a thermostatic valve and water preheated by solar energy

- ▶ Set the temperature at the instantaneous water heater to the maximum temperature.

Following an interruption to the water supply



Material losses

To ensure that the bare wire heating system is not damaged following an interruption to the water supply, the appliance must be recommissioned by taking the following steps.

- ▶ Disconnect the appliance from the power supply by removing the fuses/tripping the MCBs.
- ▶ Open the tap for one minute until the appliance and its upstream cold water inlet line are free of air.
- ▶ Switch on the power supply again.

5. Cleaning, care and maintenance

- ▶ Never use abrasive or corrosive cleaning agents. A damp cloth is sufficient for cleaning the appliance.
- ▶ Check the taps regularly. Limescale deposits at the tap outlets can be removed using commercially available descaling agents.

6. Troubleshooting

Problem	Cause	Remedy
The appliance will not start despite the DHW valve being fully open.	There is no power.	Check the fuses / MCBs in your fuse box / distribution board.
	The aerator in the tap or the shower head is scaled up or dirty.	Clean and/or descale the aerator or shower head.
	The water supply has been interrupted.	Vent the appliance and the cold water inlet line.
When hot water is being drawn off, cold water flows for a short period.	The air sensor is detecting air in the water. It briefly switches off the heating output.	The appliance restarts automatically after 1 minute.
The required temperature cannot be set.	The high limit safety cut-out and/or internal anti-scalding protection are enabled.	Deactivate the temperature limit. The internal anti-scalding protection can only be adjusted by qualified contractors.
The flow rate is too low.	ECO function is enabled.	Select a different ECO level or disable the ECO function.
No settings can be made on the programming unit.	The operating lock is enabled.	To deactivate the operating lock, press the "i" button for more than 12 seconds.



Note
 Programming unit displays and selected settings are retained following a power failure.

If you cannot remedy the fault, contact your qualified contractor. To facilitate and speed up your enquiry, please provide the serial number from the type plate (000000-0000-000000).

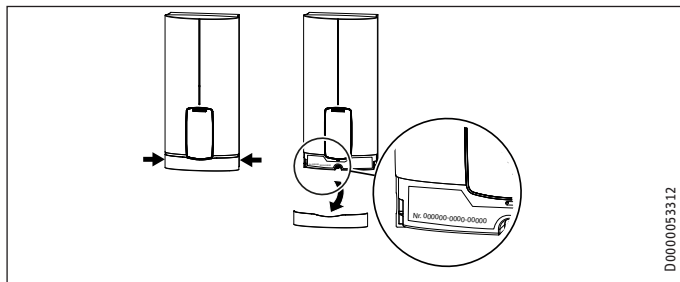

D0000053312

INSTALLATION

7. Safety

Only a qualified contractor should carry out installation, commissioning, maintenance and repair of the appliance.

7.1 General safety instructions

We guarantee trouble-free function and operational reliability only if original accessories and spare parts intended for the appliance are used.



Material losses

Observe the maximum inlet temperature. Higher temperatures may damage the appliance. You can limit the maximum inlet temperature by installing a central thermostatic valve.



WARNING Electrocutation

This appliance contains capacitors which are discharged when disconnected from the power supply. The capacitor discharge voltage may briefly exceed 60 V DC.

7.2 Shower operation



CAUTION Burns

- The appliance is suitable for supplying a shower (shower operation). If the appliance is also or exclusively used for shower operation, the qualified contractor must adjust the temperature setting range to 43 °C using the internal anti-scalding protection on the appliance. When using preheated water, ensure that the inlet temperature does not exceed 55 °C.
- In Australia, the use of a temperature controller is required to meet the requirements of AS 3498 when showers, bathtubs or washbasins are supplied with water. The maximum temperature of 50 °C must not be exceeded.

7.3 Instructions, standards and regulations



Note

Observe all applicable national and regional regulations and instructions.



Note

The installation of this appliance shall conform to the Plumbing Code of Australia (PCA), and the New Zealand Building Code.

- The IP 24 / IP 25 protection rating can only be ensured with a correctly fitted cable grommet.
- The electrical resistivity of the water must not fall below that stated on the type plate. In a linked water network, take into consideration the lowest electrical resistivity of the water. Your water supply utility will advise you of the electrical resistivity or conductivity of the water in your area.

8. Appliance description

8.1 Standard delivery

The following are delivered with the appliance:

- Wall mounting bracket
- Installation template
- 2 plugs
- 2 extensions
- 2 caps
- 2 tees
- 8 flat gaskets
- Strainer
- Plastic profile washer
- Plastic connection pieces / installation aid
- Cover and back panel guides
- Jumper for internal anti-scalding protection

8.2 Accessories

Wireless remote control

- FFB 4 Set AP

9. Preparation

9.1 Installation site



Material losses

Install the appliance in a room that is free from the risk of frost.

- ▶ Always install the appliance vertically and near the draw-off point. For horizontal installation, see chapter "Installation alternatives / Horizontal installation of the appliance".

The appliance is suitable for undersink and oversink installation.

Undersink installation

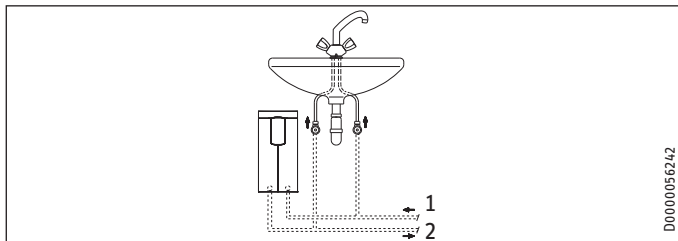

- 1 Cold water inlet
- 2 DHW outlet

Oversink installation

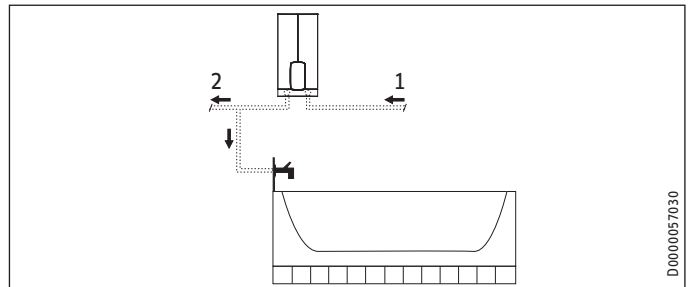

- 1 Cold water inlet
- 2 DHW outlet



Note

▶ Mount the appliance on the wall. The wall must have sufficient load bearing capacity.

9.2 Minimum clearances

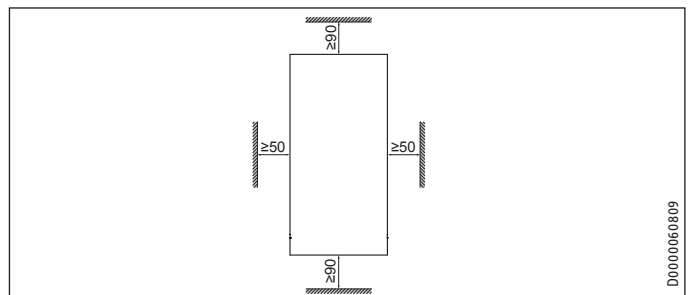

- ▶ Maintain the minimum clearances to ensure trouble-free operation of the appliance and facilitate maintenance work.

9.3 Water installation

- ▶ Flush the water line thoroughly.

Fittings

Use appropriate pressure taps. Open vented taps are not permissible.

Permissible water line materials

- Cold water inlet line:
Pipes made from galvanised steel, stainless steel, copper or plastic
- DHW outlet line:
Pipes made from stainless steel, copper or plastic



Material losses

If plastic pipework systems are used, take into account the maximum inlet temperature and the maximum permissible pressure.

Flow rate

- ▶ Ensure that the flow rate for switching on the appliance is achieved.
- ▶ If the required flow rate is not achieved when the draw-off valve is fully open, increase the water line pressure.

INSTALLATION

Installation

10. Installation

Factory settings	DHE 18 AU	DHE 27 AU
Internal anti-scalding protection	Tmax (= 60 °C)	Tmax (= 60 °C)

Standard installation	DHE 18 AU	DHE 27 AU
Electrical connection from below on unfinished walls	x	x
Water connection, installation on finished walls	x	x

For further installation options, see chapter "Alternative installation methods".

10.1 Standard installation



Note

This type of connection changes the IP rating of the appliance.

- ▶ Change the type plate. Cross out "IP 25" and mark the box "IP 24". Use a ballpoint pen to do this.

Opening the appliance

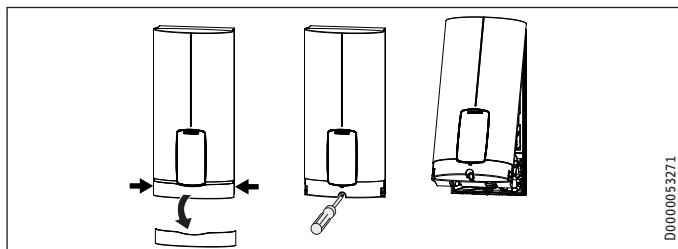

- ▶ Open the appliance by holding the fascia at the side and pulling forwards away from the appliance cover. Undo the screw. Pivot open the appliance cover.

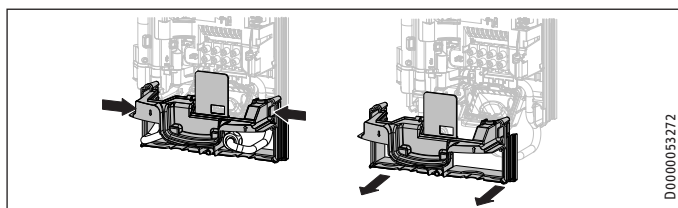

- ▶ Remove the back panel by pressing the two locking tabs and pulling the lower back panel section forwards.

Preparing the power cable on unfinished walls, for connection from below

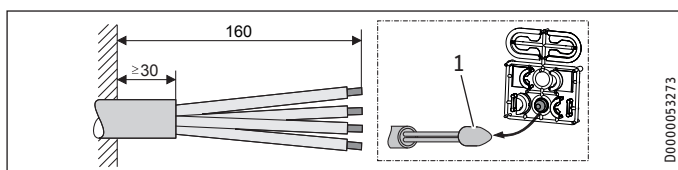

1 Cable entry installation aid

- ▶ Prepare the power cable.

Fitting the wall mounting bracket

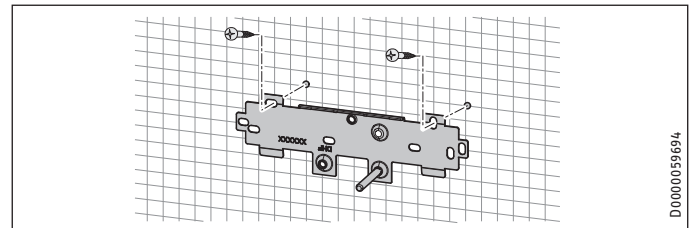

- ▶ Mark out the holes for drilling using the installation template. If the appliance is to be installed on finished walls, also mark out the fixing hole in the lower section of the template.
- ▶ Drill the holes and secure the wall mounting bracket at 2 points using suitable fixing materials (screws and rawl plugs are not part of the standard delivery).
- ▶ Fit the wall mounting bracket.

Preparing the water connection



Material losses

Carry out all water connection and installation work in accordance with regulations.

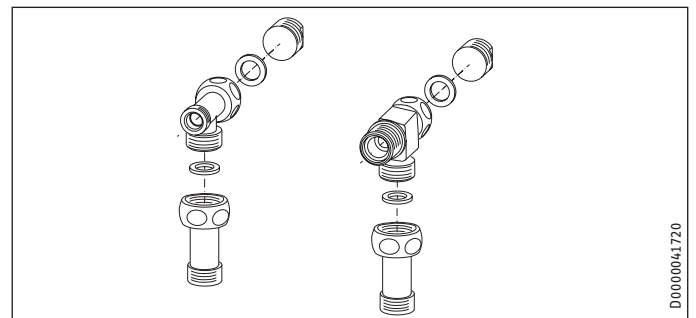

- ▶ Remove the caps from the tees.
- ▶ Fit the plugs and the extensions with gaskets.

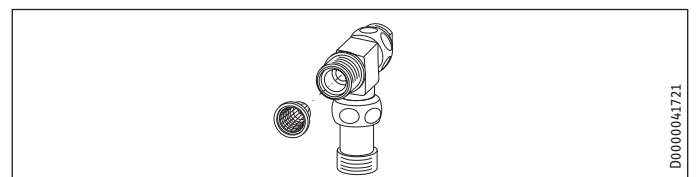

- ▶ Fit the strainer in the tee for the cold water inlet.



Damage to the appliance and environment

The strainer must be fitted for the appliance to function.

- ▶ When replacing the appliance, check that the strainer is present.

INSTALLATION

Installation

Installing the appliance



Note

If you are installing the appliance with flexible pipe connections, also secure the back panel with a screw.

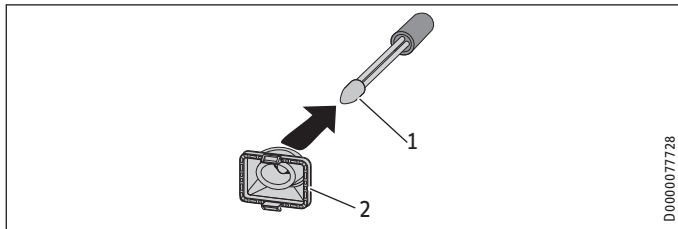

- 1 Cable entry installation aid
- 2 Cable grommet

Use the installation aid for easier wiring access through the cable grommet (see plastic parts set supplied).

- ▶ Remove the cable grommet from the back panel.
- ▶ Pull the cable grommet over the cable sheath of the power cable. For large cable cross-sections, enlarge the hole in the cable grommet if necessary.

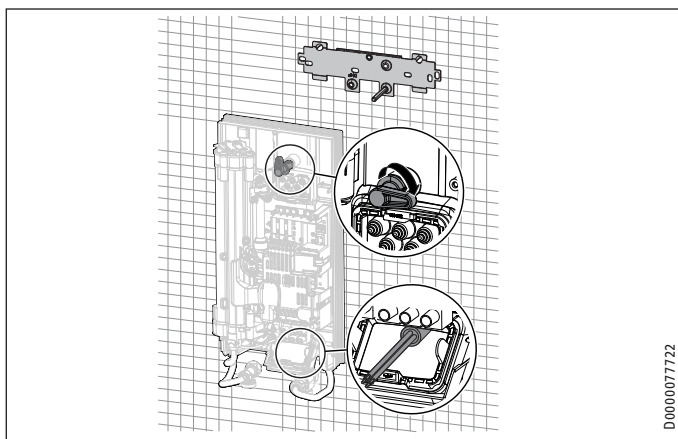

- ▶ Remove the transport protection plugs from the appliance pipe connections.
- ▶ Bend the power cable 45° upwards.
- ▶ Route the power cable and cable grommet through the back panel from the rear.
- ▶ Install the appliance on the threaded studs of the wall mounting bracket.
- ▶ Press the back panel firmly into place, aligning it correctly.
- ▶ Lock the fixing toggle by turning it 90° clockwise.
- ▶ Pull the cable grommets into the back panel until both locking tabs engage.

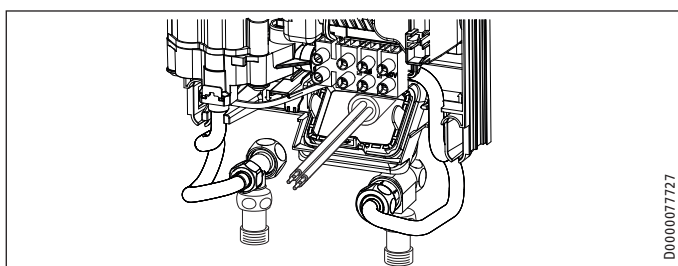

- ▶ Screw the pre-assembled parts with flat gaskets to the cold water and DHW pipes of the appliance.
- ▶ Fit the cold water inlet pipe and the DHW outlet pipe from the pipework with flat gaskets to the extensions from the appliance.

Making the electrical connection



WARNING Electrocutation

Carry out all electrical connection and installation work in accordance with relevant regulations.



WARNING Electrocutation

The connection to the power supply must be in the form of a permanent connection in conjunction with the removable cable grommet. Ensure the appliance can be separated from the power supply by an isolator that disconnects all poles with at least 3 mm contact separation.



WARNING Electrocutation

Ensure that the appliance is earthed.



Material losses

Observe the type plate. The specified rated voltage must match the power supply.

- ▶ Connect the power cable to the mains terminal.

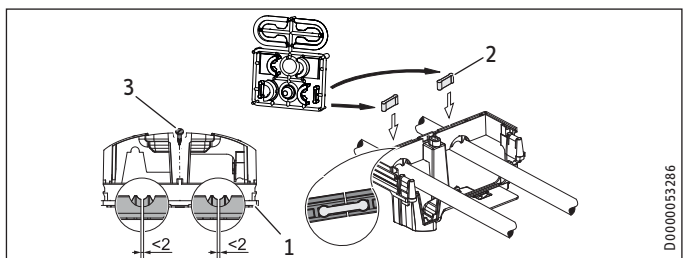

- 1 Lower back panel section
- 2 Connection piece in the standard delivery
- 3 Screw

If using threaded fittings on finished walls, the lower back panel section can also be installed after fitting the taps. To do this, carry out the following steps:

- ▶ Cut open the lower back panel section.
- ▶ Fit the lower back panel section by bending it out at the sides and guiding it over the pipes.
- ▶ Insert the connection pieces into the lower back panel section from behind.
- ▶ Click the lower back panel section into place.
- ▶ Secure the lower back panel section with a screw.



Material losses

The cover plate of the lower back panel section must not bend when installed.

INSTALLATION

Commissioning

11. Commissioning

11.1 Preparation

Internal anti-scalding protection via jumper slot

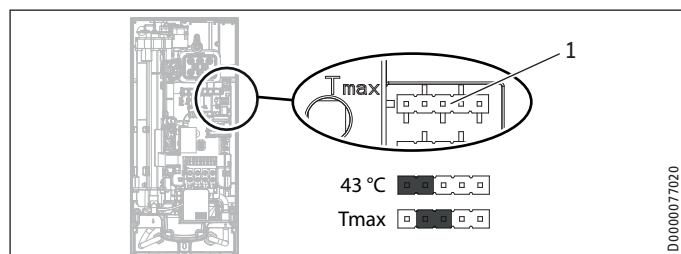

1 Jumper for anti-scalding protection setting

Jumper position	Description
43 °C	
Tmax	Factory setting (60 °C)
No jumper	Limited to 43 °C

- ▶ Install the "Anti-scalding protection setting" jumper in the required position on the top pin strip.



CAUTION Burns

If the appliance is supplied with preheated water, the internal anti-scalding protection may be exceeded.

- ▶ In this case, limit the temperature with an upstream central thermostatic valve.

11.2 Initial start-up

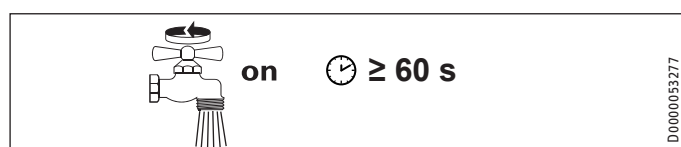

- ▶ Open and close all connected draw-off valves several times, until all air has been purged from the pipework and the appliance.
- ▶ Carry out a tightness check.

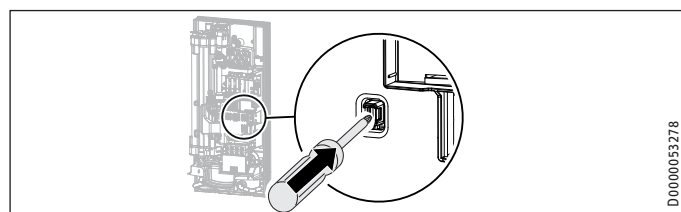

- ▶ Activate the safety switch by firmly pressing the reset button (the appliance is delivered with the safety switch disabled).

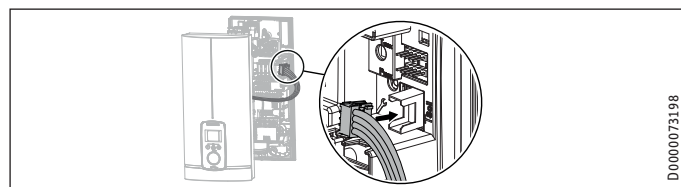

- ▶ Connect the programming unit connecting cable to the PCB.



Note

For undersink installation, the appliance cover should be turned the other way up for easier operation; see chapter "Installation alternatives / Rotated appliance cover".

Fit the appliance cover

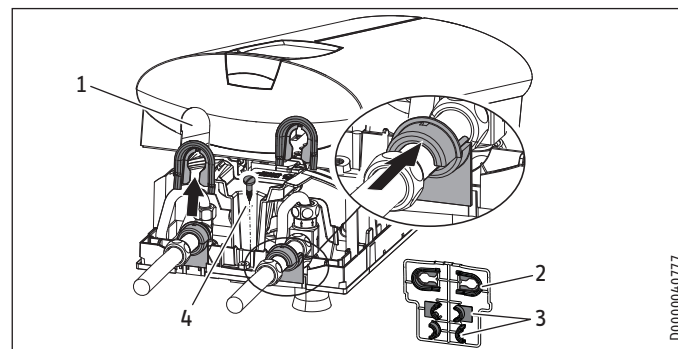

- 1 Pipe knock-out
- 2 Cover guides
- 3 Back panel guides
- 4 Fixing screw (not part of the standard delivery)

- ▶ Cleanly cut or break out the knock-out openings in the appliance cover. If necessary, use a file.



Material losses

If you cut open the wrong knock-out in the appliance cover by mistake, you must use a new appliance cover.



Note

You can compensate for a slight connection pipe offset using the tabs on the cover guides. If the connection pipes are offset, do not fit any back panel guides.

- ▶ When installing connection pipes without offset, break off the tabs on the cover guide pieces.
- ▶ Click the cover guides into place in the openings.
- ▶ Position the back panel guides on the extensions. Push them together. Then push the guides against the back panel as far they will go.

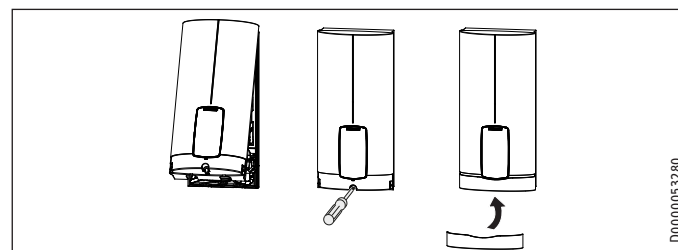

- ▶ Hook the appliance cover at the top rear into the back panel. Pivot the appliance cover downwards. Check that the appliance cover is securely seated both top and bottom.
- ▶ Secure the appliance cover with the screw.
- ▶ Fit the fascia to the appliance cover.
- ▶ Remove the protective film from the user interface.

INSTALLATION

Appliance shutdown



on

D0000053281

- ▶ Switch on the power supply.

11.2.1 Appliance handover

- ▶ Explain the appliance function to users and familiarise them with how it works.
- ▶ Make the user aware of potential dangers, especially the risk of scalding.
- ▶ Hand over the instructions.

11.3 Recommissioning



Material losses

To ensure that the bare wire heating system is not damaged following an interruption to the water supply, the appliance must be recommissioned by taking the following steps.

- ▶ Disconnect the appliance from the power supply by removing the fuses/tripping the MCBs.
- ▶ Open the tap for at least one minute until the appliance and its upstream cold water inlet line are free of air.
- ▶ Switch on the power supply again.

12. Appliance shutdown

- ▶ Isolate all poles of the appliance from the power supply.
- ▶ Drain the appliance (see chapter "Maintenance / Draining the appliance").

13. Installation alternatives

Overview of installation alternatives

Electrical connection	IP rating
On unfinished walls, connected from above	IP 25
On unfinished walls, connected from below, short power cable	IP 25
Finished walls	IP 24

Water connection	IP rating
Unfinished walls	IP 25

Other	IP rating
Installation with offset tiles	IP 25
Rotated appliance cover	IP 25
Horizontal installation of the appliance	IP 24



WARNING Electrocutation

Before any work on the appliance, disconnect all poles from the power supply.

13.1 Electrical connection from above on unfinished walls

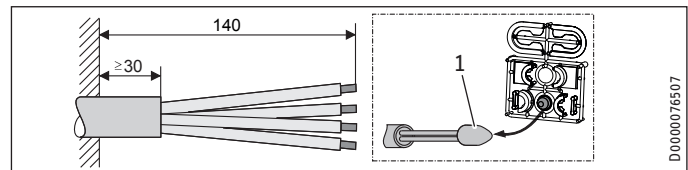

D0000076507

1 Cable entry installation aid

- ▶ Prepare the power cable.

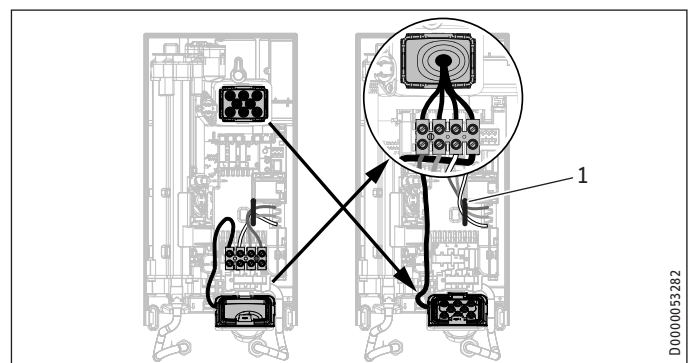

D0000053282

1 Cable routing

- ▶ Reposition the mains terminal from the bottom to the top. To do this, undo the fixing screw. Turn the mains terminal with connecting cables 180° clockwise. Route the cable around the cable guide when doing so. Secure the mains terminal in place.
- ▶ Replace the cable grommets.
- ▶ Install the cable grommet from the top at the bottom.
- ▶ Pull the cable grommet over the cable sheath of the power cable.
- ▶ Install the appliance on the threaded studs of the wall mounting bracket.
- ▶ Push the back panel firmly against the wall. Lock the fixing toggle by turning it 90° clockwise.
- ▶ Pull the cable grommets into the back panel until both locking tabs engage.
- ▶ Connect the power cable to the mains terminal.



WARNING Electrocutation

The connecting wires must not protrude beyond the level of the mains terminal.

Installation alternatives

13.2 Electrical connection on unfinished walls from below with short power cable

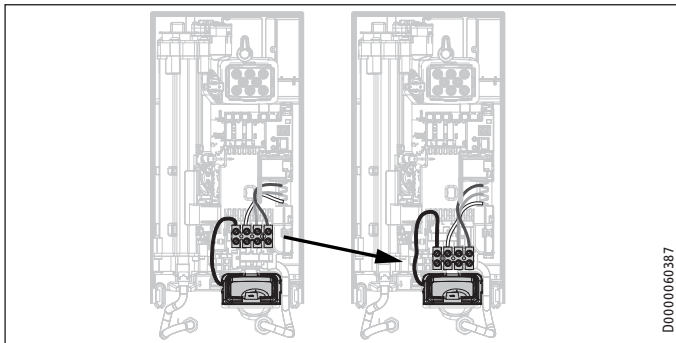

D0000060387

- Reposition the mains terminal further downwards. To do this, undo the fixing screw. Secure the mains terminal in place.

13.3 Electrical connection on finished walls



Note
This type of connection changes the IP rating of the appliance.

- Change the type plate. Cross out "IP 25" and mark the box "IP 24". Use a ballpoint pen to do this.

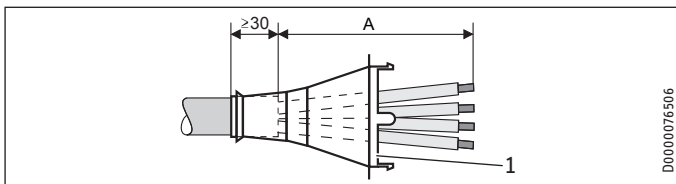

D0000076506

1 Cable grommet

Electrical connection on finished walls	Dimension A
Positioned in lower section of appliance	160
Positioned in upper section of appliance	110

- Prepare the power cable. Fit the cable grommet.



Material losses
If you break out the wrong knock-out in the back panel/appliance cover by mistake, you must use a new back panel/appliance cover.

- Cleanly cut and break out the required cable entries from the back panel and appliance cover (for the positions, see chapter "Specification / Dimensions and connections"). Deburr any sharp edges with a file.
- Route the power cable through the cable grommet.
- Connect the power cable to the mains terminal.

13.4 Water installation on unfinished walls

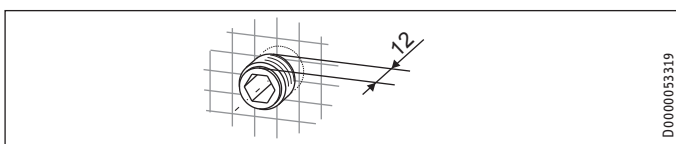

D0000053319

- Seal and screw in the twin nipples (not included in standard delivery).

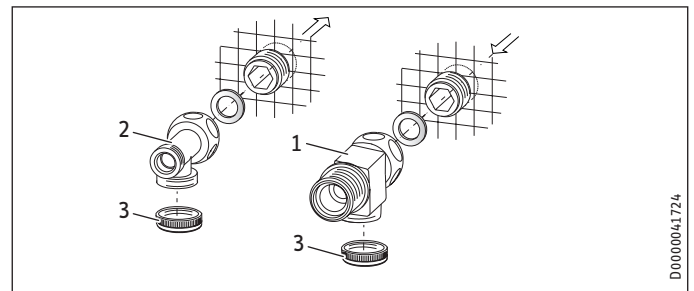

D0000041724

- 1 Tee for cold water
- 2 Tee for domestic hot water
- 3 Cap
- Fit the water connections.

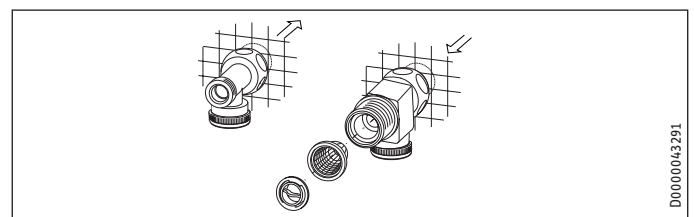

D0000043291

- Fit the strainer and the plastic profile washer in the tee for the cold water inlet.



Material losses
The strainer must be fitted for the appliance to function.

- When replacing the appliance, check that the strainer is present.

- Screw the connection pipes from the appliance to the tee.
- Open the shut-off valve in the cold water inlet line.

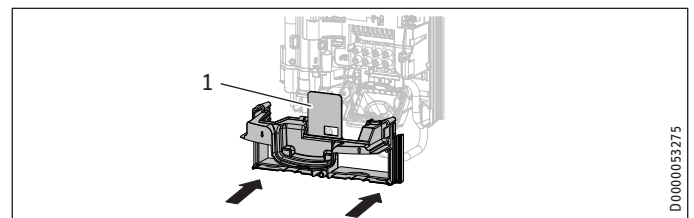

D0000053275

- 1 Diffuser on lower back panel
- Fit the lower back panel section into the back panel. Check that both locking tabs are engaged.
- Align the mounted appliance by undoing the fixing toggle, aligning the power supply and back panel, and then re-tightening the fixing toggle. If the back panel does not sit flush against the wall, you can secure the appliance at the bottom with an additional screw.



Material losses
The cover plate of the lower back panel section must not bend when installed.

13.5 Wall mounting bracket when replacing an appliance

An existing STIEBEL ELTRON wall mounting bracket may be used when replacing appliances (except the DHF instantaneous water heater), as long as the fixing screw is in the lower right position.

Replacing a DHF instantaneous water heater

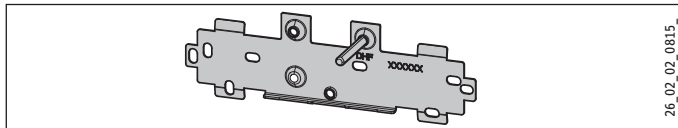

- ▶ Reposition the fixing screw on the wall mounting bracket (the fixing screw has a self-tapping thread).
- ▶ Rotate the wall mounting bracket 180° and mount it on the wall (the DHF logo is then turned towards you).

13.6 Installation with offset tiles

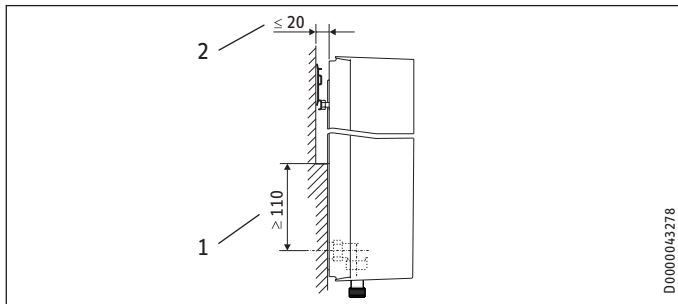

- 1 Minimum contact area of the appliance
 - 2 Maximum tile offset
- ▶ Adjust the wall clearance. Lock the back panel in place using the fixing toggle (turn 90° clockwise).

13.7 Rotated appliance cover

The appliance cover should be turned the other way up for undersink installation.

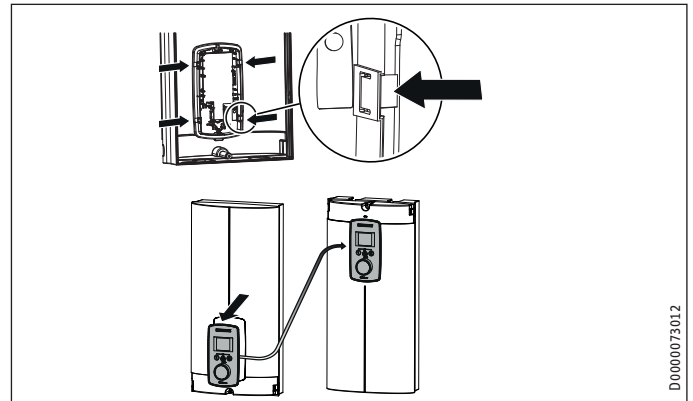

- ▶ Remove the programming unit from the appliance cover by pressing the locking hooks and removing the programming unit.
- ▶ Turn the appliance cover (not the appliance) the other way up and refit the programming unit. Push the programming unit home in parallel until all locking tabs engage. When engaging the locking tabs, apply counter pressure by pushing against the appliance cover from the inside.



WARNING Electrocutation

All 4 locking tabs on the programming unit must click into place. The locking tabs must be complete and undamaged. If the programming unit is not inserted correctly, user protection against contact with live components cannot be ensured.

- ▶ Insert the connecting cable plug of the programming unit into the PCB (see chapter "Commissioning / Initial start-up").
- ▶ Hook the appliance cover in at the bottom. Pivot the appliance cover up to the back panel.
- ▶ Secure the appliance cover.
- ▶ Fit the cover onto the appliance cover.

13.8 Operation with preheated water

You can limit the maximum inlet temperature by installing a central thermostatic valve.

13.9 Horizontal installation of the appliance



Note

For the horizontal installation alternative, please note the following points:

- Installation is only permissible with direct wall mounting.
- The installation versions "Installation with offset tiles" and "Rotated appliance cover" are not permissible.
- This type of connection changes the IP rating of the appliance. Cross out "IP 25" on the type plate and mark the box "IP 24". Use a ballpoint pen to do this.

Horizontal installation

The appliance can also be mounted horizontally on the wall (turned 90° to the left, with the water connections on the right). The installation, water and electrical connections are described in chapters "Standard installation" and "Installation alternatives".

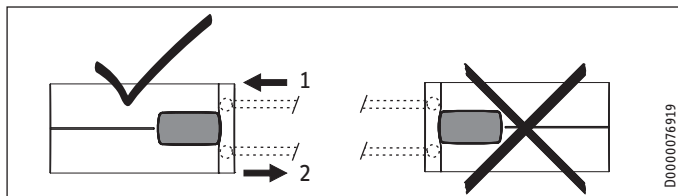

- 1 Cold water inlet
- 2 DHW outlet

Preparation

The appliance cover must be provided with a condensate drain opening of min. \varnothing 5.0 mm to max. \varnothing 6.0 mm at the marked position.

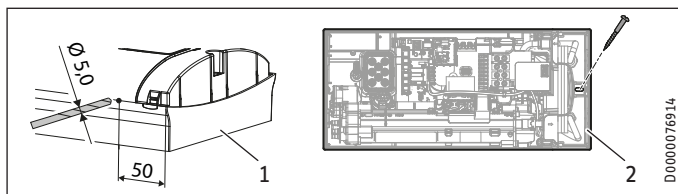

- 1 Appliance cover with opening for condensate drain
- 2 Back panel with additional fixing screw

- Drill a hole from the outside through the dismantled appliance cover at the marked point. Alternatively, you can punch a hole in the appliance cover from the inside at the marked point. In this case, you must then enlarge the hole to the required diameter from the outside. Deburr any sharp edges with a file.
- Secure the appliance back panel with an additional screw.



Material losses

An appliance cover with an existing condensate drain opening must no longer be used for vertical installation of the appliance.

14. Service information

Overview of connections

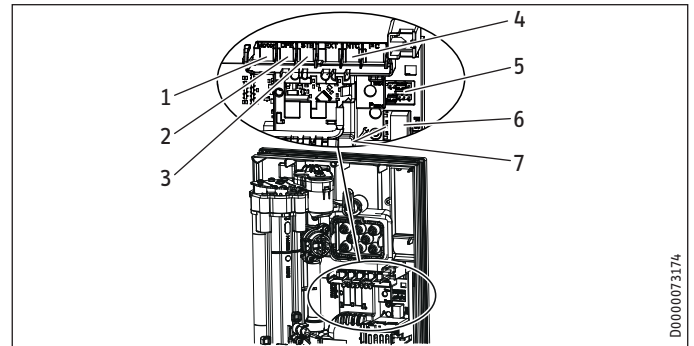

- 1 Motorised valve
- 2 Flow sensor
- 3 High limit safety cut-out, automatic reset
- 4 NTC sensor
- 5 Pin strip for anti-scalding protection
- 6 Programming unit plug-in position
- 7 Diagnostic traffic lights

Appliance cover retainer

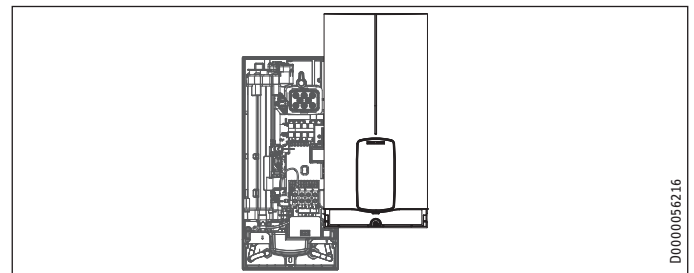

INSTALLATION

Troubleshooting

15. Troubleshooting



WARNING Electrocutation
To test the appliance, it must be connected to the power supply.



Note
When testing the appliance using the diagnostic traffic lights, water must be flowing.

Signals of the diagnostic traffic lights (LED)

	Red	Lights up in the event of a fault
	Yellow	Illuminates in heating mode/ flashes when output limit reached
	Green	Flashing: Appliance connected to power supply

Diagnostic traffic lights (draw-off mode)	Fault	Cause	Remedy
No LED illuminates	Appliance does not heat up	One or more power supply phases are missing PCB faulty	Check the fuses in the distribution board Replace the function module
Green flashing, yellow off, red off	No DHW	Appliance starting flow rate not reached; shower head/aerator scaled up Appliance starting flow rate not reached; strainer in cold water inlet dirty Flow meter not plugged in Flow meter faulty or dirty PCB faulty	Descale/replace the shower head/aerator Clean strainer Check plug-in connection; correct if necessary Replace flow meter Replace the function module
Green flashing, yellow on, red off	No display	Loose connecting cable between PCB and programming unit Faulty connecting cable between PCB and programming unit Programming unit faulty PCB faulty	Check plug-in connections; correct if necessary Check connecting cable; replace if necessary Replace programming unit Replace the function module
Green flashing, yellow on, red off	No DHW; outlet temperature does not match set value	Tap faulty Outlet sensor faulty Heating system faulty PCB faulty	Replace tap Replace outlet sensor Replace the function module Replace the function module
Green flashes, yellow flashes, red off	No DHW; outlet temperature does not match set value	Motorised valve faulty	Replace motorised valve
Green flashing, yellow off, red on	No DHW; outlet temperature does not match set value	One or more power supply phases are missing Air detection has responded	Check the fuses in the distribution board Continue draw-off for >1 min

15.1 Fault code display

If there is an appliance fault, the spanner flashes on the display.

- To call up the fault code display, press the "i" button for more than 5 seconds.

Diagnostic traffic lights (draw-off mode)	Display shown	Fault	Cause	Remedy
Green flashing, yellow off, red on	Spanner flashes (fault code display E1 and spanner)	No DHW; outlet temperature does not match set value	Safety switch not activated during "Commissioning" Safety switch was triggered by high limit safety cut-out Safety switch responds again after high limit safety cut-out has been checked; high limit safety cut-out faulty Safety switch responds again; PCB faulty	Activate the safety switch by firmly pressing the reset button Check high limit safety cut-out (plug-in connection, connecting cable); activate safety switch Replace high limit safety cut-out; activate safety switch and draw-off with maximum set value >1 min Replace the function module
Green flashing, yellow off, red on	Spanner flashes (fault code display E2 and spanner)	No DHW	PCB faulty (lead break or short circuit in inlet sensor)	Replace the function module
Green flashing, yellow off, red on	Spanner flashes (fault code display E3 and spanner)	No DHW	Short circuit in outlet sensor	Check outlet sensor; replace if necessary

16. Maintenance



WARNING Electrocutation
Before any work on the appliance, disconnect all poles from the power supply.
This appliance contains capacitors which are discharged when disconnected from the power supply. The capacitor discharge voltage may briefly exceed 60 V DC.

Draining the appliance

The appliance can be drained for maintenance work.



WARNING Burns
Hot water may escape when you drain the appliance.

- ▶ Close the shut-off valve in the cold water inlet line.
- ▶ Open all draw-off valves.
- ▶ Undo the pipe connections from the appliance.
- ▶ Store the dismantled appliance free from the risk of frost, as water residues remaining inside the appliance can freeze and cause damage.

Clean strainer

If the strainer in the threaded cold water fitting is dirty, clean it. Close the shut-off valve in the cold water inlet line before removing, cleaning and refitting the strainer.

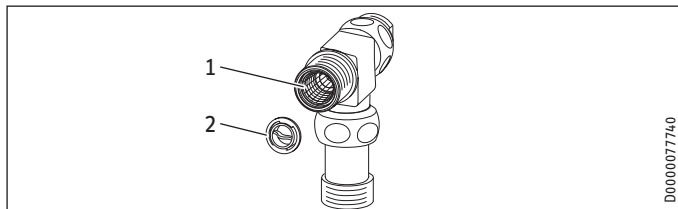

- 1 Strainer
 - 2 Plastic profile washer
- ▶ Remove the plastic profile washer and the strainer.
 - ▶ Clean the components.
 - ▶ Fit the strainer and the plastic profile washer.

17. Specification

17.1 Dimensions and connections

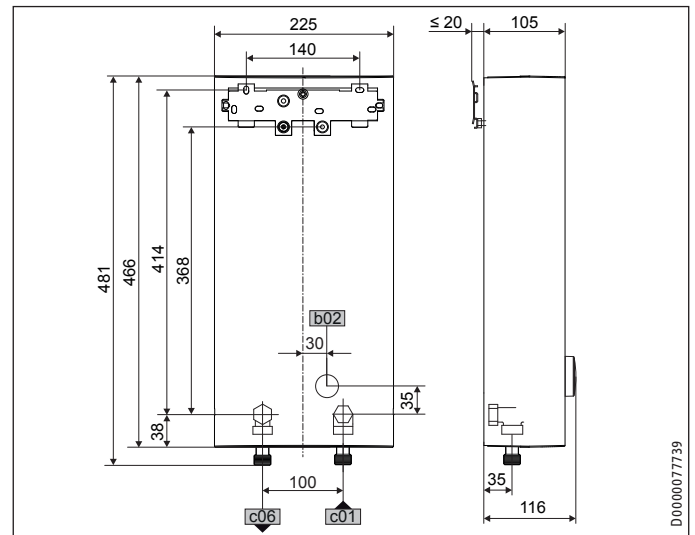

		DHE AU
b02	Entry for electrical cables I	Unfinished walls
c01	Cold water inlet	Male thread G 1/2 A
c06	DHW outlet	Male thread G 1/2 A

Alternative connection options

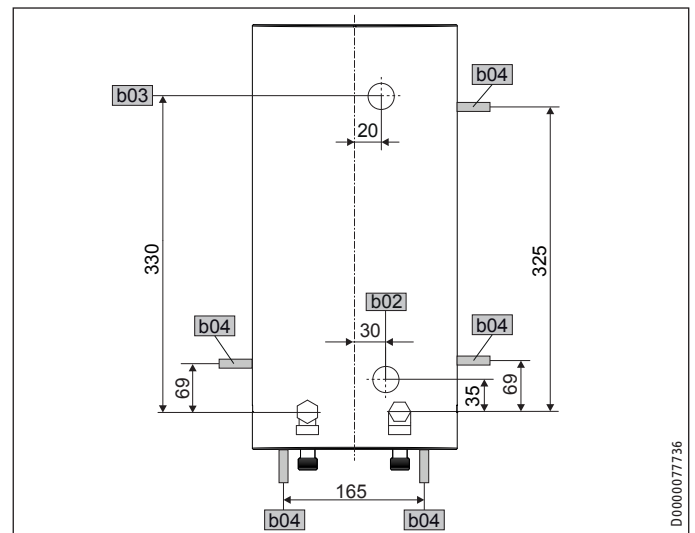

		DHE AU
b02	Entry for electrical cables I	Unfinished walls
b03	Entry for electrical cables II	Unfinished walls
b04	Entry electrical cables III	Finished walls

INSTALLATION Specification

17.2 Wiring diagram

3/PE ~ 380-415 V

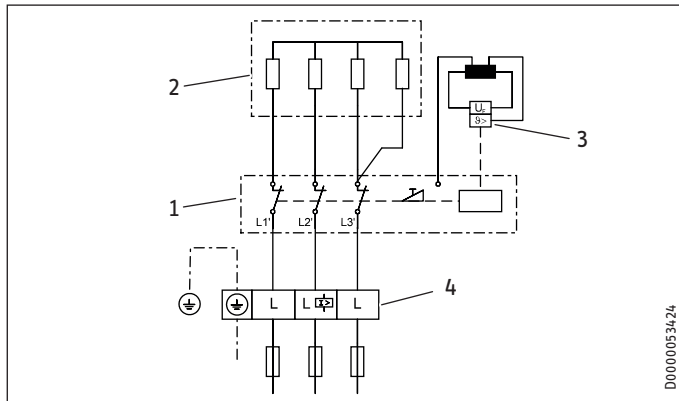

- 1 Power PCB with integral safety switch
- 2 Bare wire heating system
- 3 High limit safety cut-out
- 4 Mains terminal

17.3 DHW output

The DHW output is subject to the connected power supply, the appliance's connected load and the cold water inlet temperature. The rated voltage and rated output can be found on the type plate.

Connected load in kW		38 °C DHW output in L/min.				
Rated voltage		Cold water inlet temperature				
380 V	400 V	415 V	5 °C	10 °C	15 °C	20 °C
DHE 18 AU						
16.2			7.0	8.3	10.1	12.9
	18.0		7.8	9.2	11.2	14.3
		19.4	8.4	9.9	12.0	15.4
DHE 27 AU						
23.5			10.2	12.0	14.6	18.7
	26.0		11.3	13.3	16.1	20.6
		28.0	12.1	14.3	17.4	22.2

Connected load in kW		50 °C DHW output in L/min.				
Rated voltage		Cold water inlet temperature				
380 V	400 V	415 V	5 °C	10 °C	15 °C	20 °C
DHE 18 AU						
16.2			5.1	5.8	6.6	7.7
	18.0		5.7	6.4	7.3	8.6
		19.4	6.2	6.9	7.9	9.2
DHE 27 AU						
23.5			7.5	8.4	9.6	11.2
	26.0		8.3	9.3	10.6	12.4
		28.0	8.9	10.0	11.4	13.3

17.4 Application areas / conversion table

Electrical resistivity and electrical conductivity

Standard specification at 15 °C			20 °C			25 °C		
Resistivity $\rho \geq$	Conductivity $\sigma \leq$		Resistivity $\rho \geq$	Conductivity $\sigma \leq$		Resistivity $\rho \geq$	Conductivity $\sigma \leq$	
Ωcm	mS/m	$\mu\text{S/cm}$	Ωcm	mS/m	$\mu\text{S/cm}$	Ωcm	mS/m	$\mu\text{S/cm}$
900	111	1111	800	125	1250	735	136	1361

17.5 Pressure drop

Fittings

Tap pressure drop at a flow rate of 10 L/min	
Mono lever mixer tap, approx.	MPa 0.04 - 0.08
Thermostatic valve, approx.	MPa 0.03 - 0.05
Shower head, approx.	MPa 0.03 - 0.15

Sizing the pipework

When calculating the size of the pipework, an appliance pressure drop of 0.1 MPa is recommended.

17.6 Fault conditions

In the event of a fault, loads up to 80 °C at a pressure of 1.0 MPa can occur very briefly in the installation.

INSTALLATION | ENVIRONMENT AND RECYCLING

Specification

17.7 Data table

		DHE 18 AU			DHE 27 AU		
		202658			202659		
Electrical data							
Rated voltage	V	380	400	415	380	400	415
Rated output	kW	16.2	18	19.4	23.5	26	28
Rated current	A	24.7	26	27	35.6	37.7	38.9
Fuse protection	A	25	25	32			40
Frequency	Hz	50/60	50/60	50/-			50/-
Phases				3/PE			3/PE
Max. mains impedance at 50 Hz	Ω	0.331	0.315	0.304	0.221	0.210	
Resistivity $\rho_{15} \geq$	Ω cm			900			900
Conductivity $\sigma_{15} \leq$	$\mu S/cm$			1111			1111
Connections							
Water connection				G 1/2 A			G 1/2 A
Application limits							
Max. permissible pressure	MPa			1			1
Max. inlet temperature for reheating	$^{\circ}C$			55			55
Values							
Max. inlet temperature (e.g. pasteurisation)	$^{\circ}C$			70			70
On	l/min			>2.5			>2.5
Flow rate at 28 K	l/min			9.9 at 415 V			14.3 at 415 V
Flow rate at 50 K	l/min			5.6 at 415 V			8.0 at 415 V
Pressure drop for flow rate at 50 K (without flow limiter)	MPa			0.06			0.14
Hydraulic data							
Nominal capacity	l			0.4			0.4
Versions							
Adjustable connected load				-			-
Temperature settings	$^{\circ}C$			Off, 20-60			Off, 20-60
Protection class				1			1
Insulating block				Plastic			Plastic
Heating system heat generator				Bare wire			Bare wire
Cover and back panel				Plastic			Plastic
Colour				White			White
IP rating				IP 25			IP 25
Dimensions							
Height	mm			466			466
Width	mm			225			225
Depth	mm			116			116
Weights							
Weight	kg			3.2			3.2



Note

The appliance conforms to IEC 61000-3-12.

Environment and recycling

We would ask you to help protect the environment. After use, dispose of the various materials in accordance with national regulations.

WARRANTY

Who gives the warranty

1. The warranty is given by Stiebel Eltron (Aust) Pty Ltd (A.B.N. 82 066 271 083) of 294 Salmon Street, Port Melbourne, Victoria, 3207 ("we", "us" or "our").

The warranty

2. This warranty applies to the Stiebel Eltron Water Heaters - WaterMark Approved (the "unit") listed within this operating and installation guide manufactured after 1 May 2015.
3. Subject to the warranty exclusions we will repair or replace, at our absolute discretion, a faulty component in your unit free of charge if it fails to operate in accordance with its specifications during the warranty period.
4. If we repair or replace a faulty component to your unit under this warranty, the warranty period is not extended from the time of the repair or replacement.
5. The warranty period commences on the date of completion of the installation of the unit. Where the date of completion of installation is not known, then the warranty period will commence 2 months after the date of manufacture.
6. The warranty period for a unit used for domestic purposes is shown in the table below. Domestic purposes means that the unit is used in a domestic dwelling.

Component	Warranty period
All components	5 years from the date of completion of the installation of the unit.

7. The warranty period for a unit used for commercial purposes is shown in the table below. Commercial purposes means that the unit is used for a non-domestic purpose and includes but not limited to being used in a motel, hotel, mining camp or nursing home.

Component	Warranty period
All components	1 year from the date of completion of the installation of the unit.

Your entitlement to make a warranty claim

8. You are entitled to make a warranty claim if:
 - 8.1. you own the unit or if you have the owner's consent to represent the owner of the unit;
 - 8.2. you contact us within a reasonable time of discovering the problem with the unit;

How you make a warranty claim

9. To make a warranty claim you must provide us with the following information:
 - 9.1. The model number of the unit;
 - 9.2. A description of the problem with the unit;
 - 9.3. The name, address and contact details (such as phone number and e-mail address) of the owner;
 - 9.4. The address where the unit is installed and the location (e.g. in laundry);
 - 9.5. The serial number of the unit;
 - 9.6. The date of purchase of the unit and the name of the seller of the unit;
 - 9.7. The date of installation of the unit;
 - 9.8. A copy of the certificate of compliance when the unit was installed.
10. The contact details for you to make your warranty claim are:

Name: Stiebel Eltron (Aust) Pty Ltd
Address: 294 Salmon Street, Port Melbourne, Victoria, 3207
Telephone: 1800 153 351
(8.00 am to 5.00 pm AEST Monday to Friday)
Contact person: Customer Service Representative
E-mail: service@stiebel-eltron.com.au

11. We will arrange a suitable time with you to inspect and test the unit.

Warranty exclusions

12. We may reject your warranty claim if:
 - 12.1. The unit was not installed by registered and qualified tradespeople.
 - 12.2. The unit was not installed and commissioned:
 - (a) in Australia;
 - (b) in accordance with the Operating and Installation Guide; and
 - (c) in accordance with the relevant statutory and local requirements of the State or Territory in which the unit is installed.
 - 12.3. The unit has not been operated or maintained in accordance with the Operating and Installation Guide.
 - 12.4. The unit does not bear its original Serial Number for Rating Label.
 - 12.5. The unit was damaged by any or any combination of the following:
 - (a) normal fair wear and tear;
 - (b) connection to an incorrect water supply;
 - (c) connection to water from a bore, dam or swimming pool;
 - (d) connection to an incorrect power supply;
 - (e) connection to faulty equipment, such as damaged valves;
 - (f) foreign matter in the water supply, such as sludge or sediment;
 - (g) corrosive elements in the water supply;
 - (h) accidental damage;
 - (i) act of God, including damage by flood, storm, fire, lightning strike and the like;
 - (j) excessive water pressure, negative water pressure (partial vacuum) or water pressure pulsation;
 - (k) ingress of vermin.
 - 12.6. The unit was damaged before it was installed e.g. it was damaged in transit.
 - 12.7. An unauthorised person has modified, serviced, repaired or attempted to repair the unit without our consent.
 - 12.8. Non genuine parts other than those manufactured or approved by us have been used on the unit.
13. We may charge you:
 - 13.1. for any additional transport costs if the unit is installed more than 30 kilometres from our closest authorised service technician.
 - 13.2. for the extra time it takes our authorised service technician to access the unit for inspection and testing if it is not sited in accordance with the Operating and Installation Guide and not readily accessible for inspection.
 - 13.3. for any extra costs of our authorised service technician to make the unit safe for inspection.
14. You must ensure that access to the unit by our authorised service technician is safe and free from obstruction.
15. Our authorised service technician may refuse to inspect and test the unit until you provide safe and free access to it, at your cost.
16. If we reject your warranty claim in accordance with clause 12, we may charge you for our authorised service technician's labour costs to inspect and test the unit.
17. In order to properly test the unit we may remove it to another location for testing.

Australian Consumer Law

18. Our goods come with guarantees that cannot be excluded under the Australian Consumer Law. You are entitled to a replacement or refund for a major failure and compensation for any other reasonably foreseeable loss or damage. You are also entitled to have the goods repaired or replaced if the goods fail to be of acceptable quality and the failure does not amount to a major failure.
19. The Stiebel Eltron warranty for the unit is in addition to any rights and remedies you may have under the Australian Consumer Law.

D0000053038

NOTES

Deutschland

STIEBEL ELTRON GmbH & Co. KG
Dr.-Stiebel-Straße 33 | 37603 Holzminden
Tel. 05531 702-0 | Fax 05531 702-480
info@stiebel-eltron.de
www.stiebel-eltron.de

Verkauf

Tel. 05531 702-110 | Fax 05531 702-95108 | info-center@stiebel-eltron.de

Kundendienst

Tel. 05531 702-111 | Fax 05531 702-95890 | kundendienst@stiebel-eltron.de

Ersatzteilverkauf

Tel. 05531 702-120 | Fax 05531 702-95335 | ersatzteile@stiebel-eltron.de

Australia

STIEBEL ELTRON Australia Pty. Ltd.
294 Salmon Street | Port Melbourne VIC 3207
Tel. 03 9645-1833 | Fax 03 9644-5091
info@stiebel-eltron.com.au
www.stiebel-eltron.com.au

Austria

STIEBEL ELTRON Ges.m.b.H.
Gewerbegebiet Neubau-Nord
Margaritenstraße 4 A | 4063 Hörsching
Tel. 07221 74600-0 | Fax 07221 74600-4
info@stiebel-eltron.at
www.stiebel-eltron.at

Belgium

STIEBEL ELTRON bvba/sprl
't Hofveld 6 - D1 | 1702 Groot-Bijgaarden
Tel. 02 42322-22 | Fax 02 42322-12
info@stiebel-eltron.be
www.stiebel-eltron.be

China

STIEBEL ELTRON (Tianjin) Electric Appliance
Co., Ltd.
Plant C3, XEDA International Industry City
Xiqing Economic Development Area
300385 Tianjin
Tel. 022 8396 2077 | Fax 022 8396 2075
info@stiebel-eltron.cn
www.stiebel-eltron.cn

Czech Republic

STIEBEL ELTRON spol. s r.o.
Dopraváků 749/3 | 184 00 Praha 8
Tel. 251116-111 | Fax 235512-122
info@stiebel-eltron.cz
www.stiebel-eltron.cz

Finland

STIEBEL ELTRON OY
Kapinakuja 1 | 04600 Mäntsälä
Tel. 020 720-9988
info@stiebel-eltron.fi
www.stiebel-eltron.fi

France

STIEBEL ELTRON SAS
7-9, rue des Selliers
B.P 85107 | 57073 Metz-Cédex 3
Tel. 0387 7438-88 | Fax 0387 7468-26
info@stiebel-eltron.fr
www.stiebel-eltron.fr

Hungary

STIEBEL ELTRON Kft.
Gyár u. 2 | 2040 Budaörs
Tel. 01 250-6055 | Fax 01 368-8097
info@stiebel-eltron.hu
www.stiebel-eltron.hu

Japan

NIHON STIEBEL Co. Ltd.
Kowa Kawasaki Nishiguchi Building 8F
66-2 Horikawa-Cho
Saiwai-Ku | 212-0013 Kawasaki
Tel. 044 540-3200 | Fax 044 540-3210
info@nihonstiebel.co.jp
www.nihonstiebel.co.jp

Netherlands

STIEBEL ELTRON Nederland B.V.
Daviotenweg 36 | 5222 BH 's-Hertogenbosch
Tel. 073 623-0000 | Fax 073 623-1141
info@stiebel-eltron.nl
www.stiebel-eltron.nl

New Zealand

Stiebel Eltron NZ Limited
61 Barrys Point Road | Auckland 0622
Tel. +64 9486 2221
info@stiebel-eltron.co.nz
www.stiebel-eltron.co.nz

Poland

STIEBEL ELTRON Polska Sp. z o.o.
ul. Działkowa 2 | 02-234 Warszawa
Tel. 022 60920-30 | Fax 022 60920-29
biuro@stiebel-eltron.pl
www.stiebel-eltron.pl

Russia

STIEBEL ELTRON LLC RUSSIA
Urzhumskaya street 4,
building 2 | 129343 Moscow
Tel. +7 495 125 0 125
info@stiebel-eltron.ru
www.stiebel-eltron.ru

Slovakia

STIEBEL ELTRON Slovakia, s.r.o.
Hlavná 1 | 058 01 Poprad
Tel. 052 7127-125 | Fax 052 7127-148
info@stiebel-eltron.sk
www.stiebel-eltron.sk

Switzerland

STIEBEL ELTRON AG
Industrie West
Gass 8 | 5242 Lupfig
Tel. 056 4640-500 | Fax 056 4640-501
info@stiebel-eltron.ch
www.stiebel-eltron.ch

Thailand

STIEBEL ELTRON Asia Ltd.
469 Moo 2 Tambol Klong-Jik
Amphur Bangpa-In | 13160 Ayutthaya
Tel. 035 220088 | Fax 035 221188
info@stiebel-eltronasia.com
www.stiebel-eltronasia.com

United Kingdom and Ireland

STIEBEL ELTRON UK Ltd.
Unit 12 Stadium Court
Stadium Road | CH62 3RP Bromborough
Tel. 0151 346-2300 | Fax 0151 334-2913
info@stiebel-eltron.co.uk
www.stiebel-eltron.co.uk

United States of America

STIEBEL ELTRON, Inc.
17 West Street | 01088 West Hatfield MA
Tel. 0413 247-3380 | Fax 0413 247-3369
info@stiebel-eltron-usa.com
www.stiebel-eltron-usa.com

STIEBEL ELTRON



Irrtum und technische Änderungen vorbehalten! | Subject to errors and technical changes! | Sous réserve d'erreurs et de modifications techniques! | Onder voorbehoud van vergissingen en technische wijzigingen! | Salvo error o modificación técnica! | Excepto erro ou alteração técnica | Zastrzeżone zmiany techniczne i ewentualne błędy | Omyly a technické změny jsou vyhrazeny! | A muszaki változtatások és tévedések jogát fenntartjuk! | Отсутствие ошибок не гарантируется. Возможны технические изменения. | Chyby a technické zmeny sú vyhradené!

Stand 9646