

henden™

Inverter Heat Pump

INSTALLATION & OWNER'S MANUAL

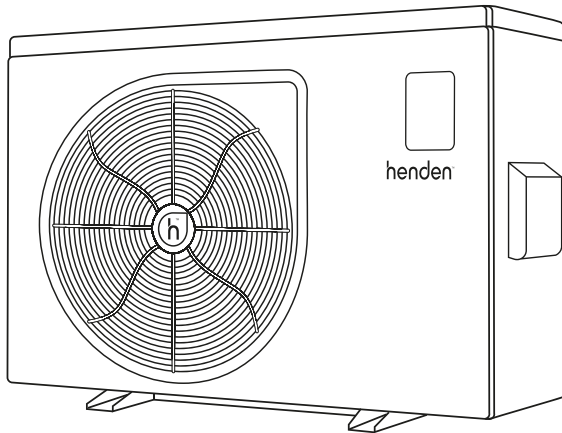

IMPORTANT
Please read carefully



CAUTIONS AND WARNINGS:

Installation and maintenance must be handled by a professional pool builder/service agent. Repairs should be carried out in a well ventilated area.

Failure to follow these instructions and comply with all applicable codes may cause serious bodily injury and/or property damage.

This Inverter Heat Pump contains R32

refrigerant gas which is a flammable substance under certain conditions.

Turn off the power during thunderstorms and severe weather.

The Inverter Heat Pump must be positioned on a concrete base. It is recommended that the frame is secured using M10 bolts.

Do not lift the Inverter Heat Pump using the water unions.

Contents

Inverter Heat Pump

Introduction	4
Helpful hints	4
In the box	5
Electrical set up	6
Installation	7
First time start up	10
Typical installation	13
Alternative installation options	14
Operation	21
App functionality	28
Specifications	31
Dimensions	32
Maintenance	33
Winterising	34
Troubleshooting	35
Error codes	36
Frequency conversion board fault	38
Exploded diagram (9kw/14kw/17kw/20kw)	40
Spare parts (9kw/14kw/17kw/20kw)	41
Exploded diagram (24kw/28kw)	42
Spare parts (24kw/28kw)	43
Warranty	44
Notes	45

INTRODUCTION

Thank you for purchasing a Henden Inverter Heat Pump.

Harness the power of this high performing heat pump. Built with inverter technology for energy efficiency and designed for super quiet operation, this sleek and compact heat pump is perfect for Australian residential pools.

HELPFUL HINTS

- › The surroundings of the Henden Inverter Heat Pump should be kept clear to avoid restricting ventilation.
- › Install the Henden Inverter Heat Pump in a well ventilated, outside area.
- › Regularly check the condensate hose for blockages and clean as necessary.
- › Ensure the Wi-Fi strength at the site of installation is strong (more than -50dB is recommended).
- › Install the Henden Inverter Heat Pump in line with the ventilation diagrams in this manual.
- › For a complete heating solution, pair with a Henden 550 Micron Solar Pool Cover. This addition helps reduce energy consumption, heat loss and water evaporation.

IN THE BOX

Henden Inverter Heat Pump

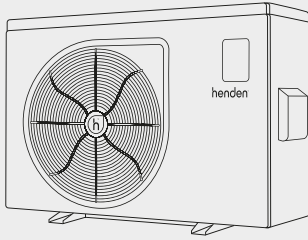

X2 union tails

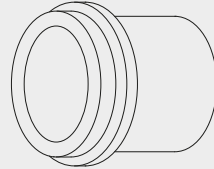

X4 rubber feet

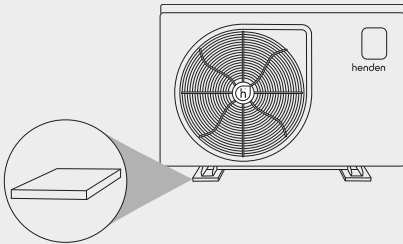



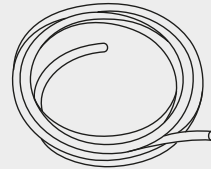

1.5 metre drain hose

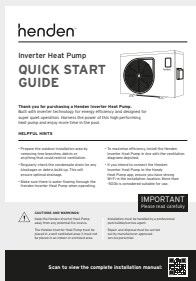

Quick Start Guide



ELECTRICAL SET UP

-  Always use a qualified electrician to perform any electrical work. A licensed electrician must read the information before connecting.
-  The Henden Inverter Heat Pump must be earthed and equipotential bonded.
-  Ensure the power cable and circuit breaker are of suitable size for the heater being installed. See specification sheet on page 27 for max input power.
-  Check that there is adequate voltage and current available at the heater connection to run the unit. Voltage range should be 220-230 volts for single phase. Voltage ranges outside these parameters will damage the Henden Inverter Heat Pump.

- 1** Ensure power is disconnected during installation or service.
- 2** Always comply with the national and local electrical codes and standards.
- 3** Ensure electrical cable size is adequate for heater requirements at the installation location.

INSTALLATION

Positioning the Henden Inverter Heat Pump

1 To begin, position the Henden Inverter Heat Pump on solid level ground outside. Do not place the unit in an enclosed area.

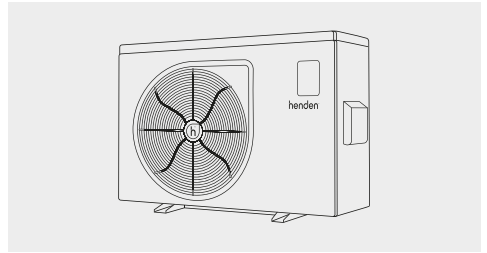

2 Check that there are no objects blocking the air inlet and that the minimum clearance guidelines displayed are followed.

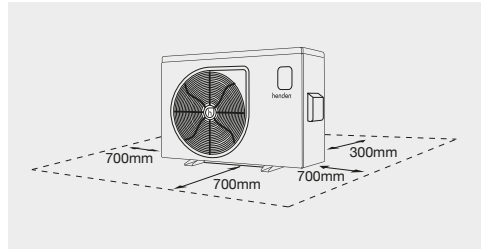

3 Place the 4 rubber feet supplied under the Henden Inverter Heat Pump.

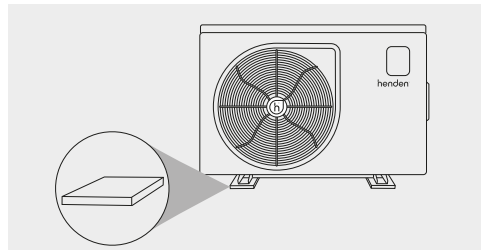

4 Ensure the Henden Inverter Heat Pump is equipped with a circuit breaker and electrical isolation switch.

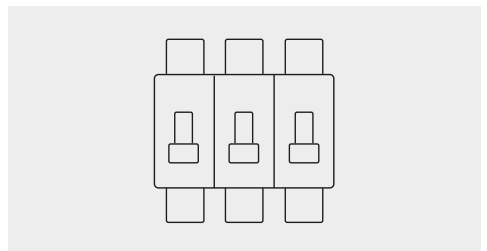

INSTALLATION

Connecting the condensation drain

- 1 Locate the barb under the heater and push the supplied drain hose on securely.

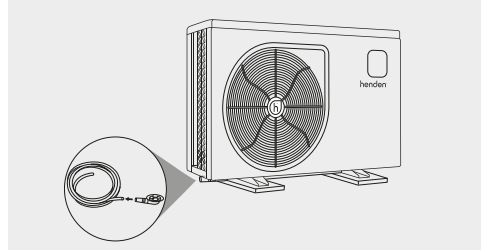

- 2 Run the drain hose downhill to a suitable location. For example, a garden or nearby stormwater drain.

Note: the hose can drain up to 10 litres of condensation per hour.

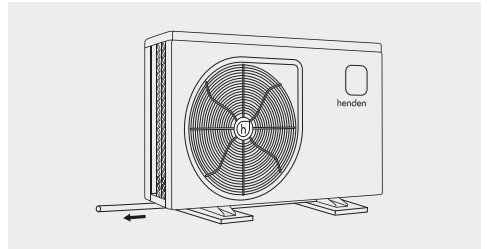

INSTALLATION

Connecting the pipework

- 1 Using the 40mm tail supplied, connect the inlet of the Henden Inverter Heat Pump downstream, after the pool pump and filter.

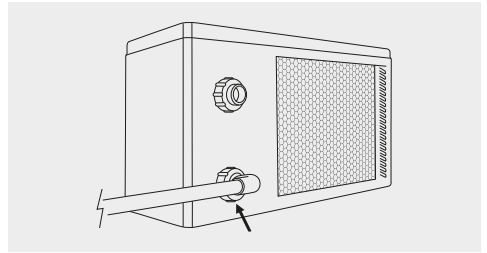

- 2 Using the 40mm tail supplied, connect the outlet upstream before any chlorinators, acid injection or other chemical dosing systems.

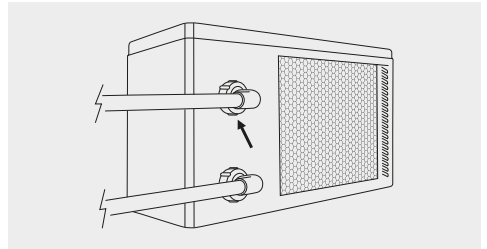

Setting up the flow bypass

- 1 Create a flow bypass between the inlet and outlet pipework to ensure optimal efficiency. See an example of this using 3 valves adjacent.

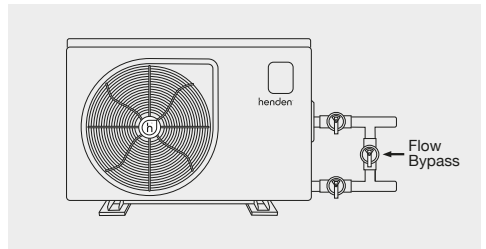

FIRST TIME START UP

Powering the Henden Inverter Heat Pump

- 1 With the bypass valve fully open, turn the pool pump on.

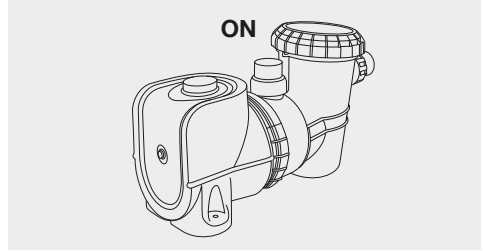

- 2 Check there are no water leaks and verify adequate flow to and from the pool.

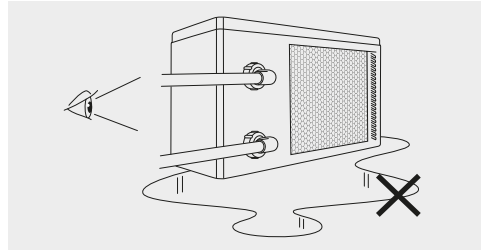

- 3 Turn on the electrical power supply to the Henden Inverter Heat Pump. If hardwired, turn on the isolation switch.

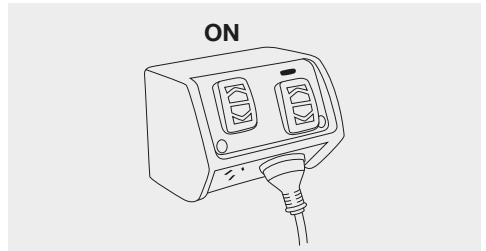

- 4 Press the power symbol on the control panel. The Henden Inverter Heat Pump will turn on within a few seconds.



FIRST TIME START UP

- 5** To adjust the bypass and calibrate the flow rate, open all isolating valves.

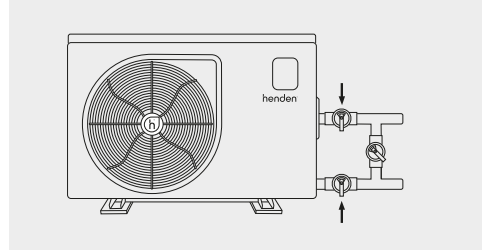

- 6** Fully close the flow bypass and switch the Henden Inverter Heat Pump to the maximum temperature.

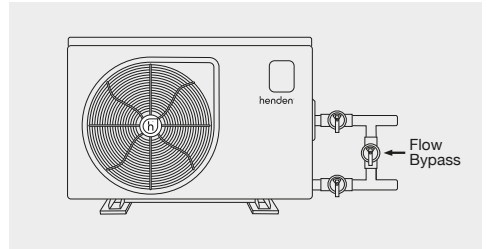

- 7** Wait 3-4 minutes until the Henden Inverter Heat Pump is at 100% capacity.

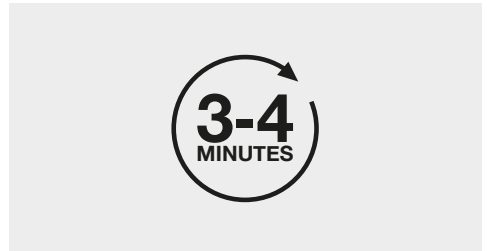

- 8** Slowly open the flow bypass valve to increase the temperature differential between the inlet and outlet. Closing the bypass valve will decrease the temperature differential. Adjust until optimum differential of 2-3 °C is achieved.

Handy Tip! Wait two minutes between each adjustment.

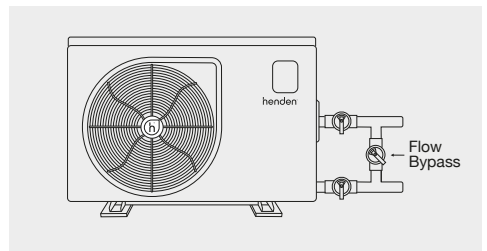

FIRST TIME START UP

- 9** The flow bypass set up is successful when the temperature difference between the inlet and outlet is 2-3 °C. At this point, lock the position of the bypass if possible.



- 10** To test the flow switch, ensure the Henden Inverter Heat Pump is operating, then turn the pool pump off. If the flow switch is working, the Henden Inverter Heat Pump should turn off automatically and the control panel should display E3 indicating no flow.

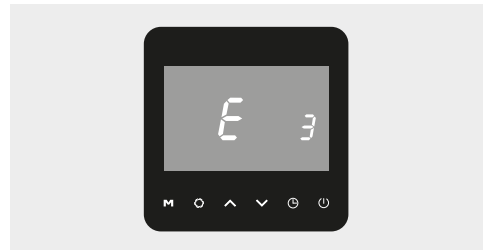

- 11** After the compressor has been running for a few minutes, the air leaving the Henden Inverter Heat Pump should be 5-10°C cooler than the ambient air temperature.

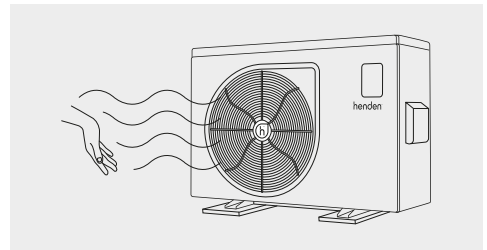

- 12** The initial start up is complete. Allow the Henden Inverter Heat Pump to run 24 hours per day until the desired pool temperature is reached. This can take several days.



TYPICAL INSTALLATION

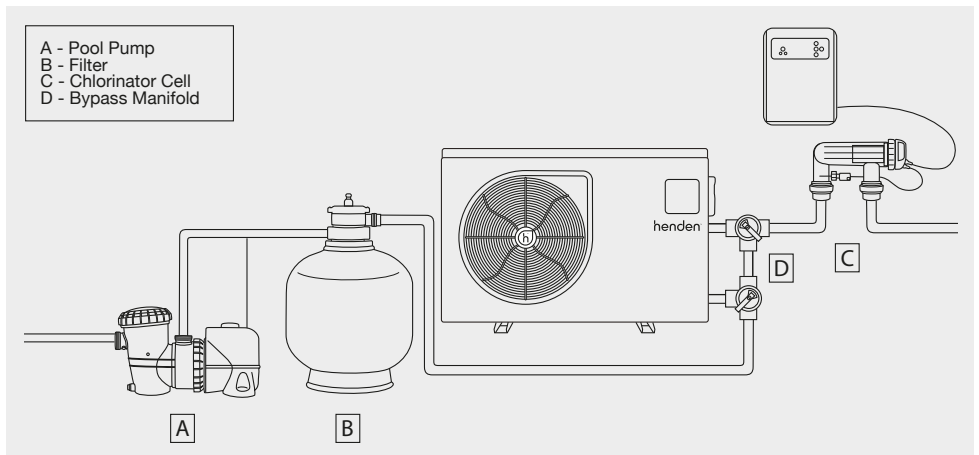

Flow switch activated heating

- 1 The Henden Inverter Heat pump can be left in an "ON" state and will activate/ deactivate the heating process using the inbuilt flow sensor.
- 2 While the circulation pump is running, the Henden Inverter Heat Pump will continue to monitor the flow and temperature.
- 3 When the Henden Inverter Heat Pump detects a loss of flow the Heater will power off and an E3 - 'Low Flow' error message will be displayed.
- 4 Once the flow is restored the alarm will clear, and the heating process will resume.



ALTERNATIVE INSTALLATION OPTIONS

External Automation Control

-  This Henden Inverter Heat Pump contains electrical equipment. Always use a licensed professional and never remove panels without disconnecting the power.
-  Please check with the automation system provider that the connection is a dry contact switch and the best way to install with their equipment.

The Henden Inverter Heat Pump can be paired with an external automation controllers. To connect the controller, follow the steps below.

- 1** Access the electrical terminals using the steps from page 14.

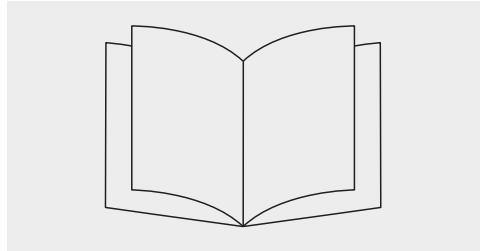

- 2** Locate the loop wire in terminals 5 and 6 then loosen the terminal screws and remove the loop wire.

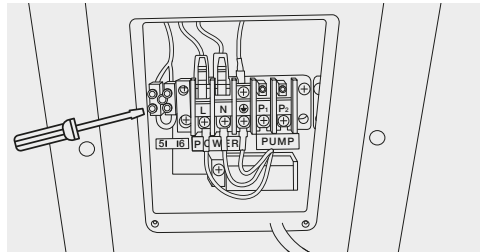

- 3** Insert the control wire from the automation unit into terminals 5 and 6 then re-tighten the terminal screws.

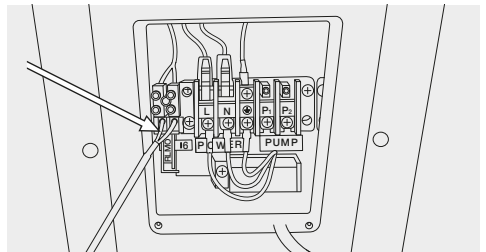

ALTERNATIVE INSTALLATION OPTIONS

- 4** The external automation controller will now override the power control the Henden Inverter Heat Pump.

Handy Tip: If the Henden Inverter Heat Pump display reads "OFF" check the heat pump setting in the external controller.

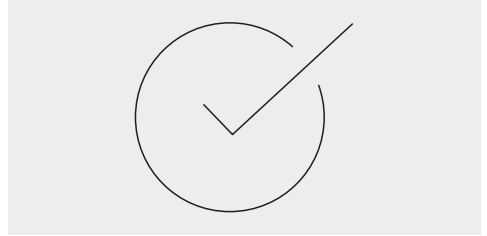

Handy Tip: If the external controller uses a temperature sensor, set the Henden Inverter Heat pump to its maximum temperature to allow full override from external Controller.

Independent circulation pump

Handy Tip: This set up is only when there is dedicated heating pipework which can operate independent of the filtration system.

Handy Tip: For this set up, it is recommended to install a single power point for the circulation pump to plug into for any future service work to the pump which may be required.

WARNING: the maximum load for the relay is 10A.

 This Henden Inverter Heat Pump contains electrical equipment. Always use a licensed professional and never remove panels without disconnecting the power.

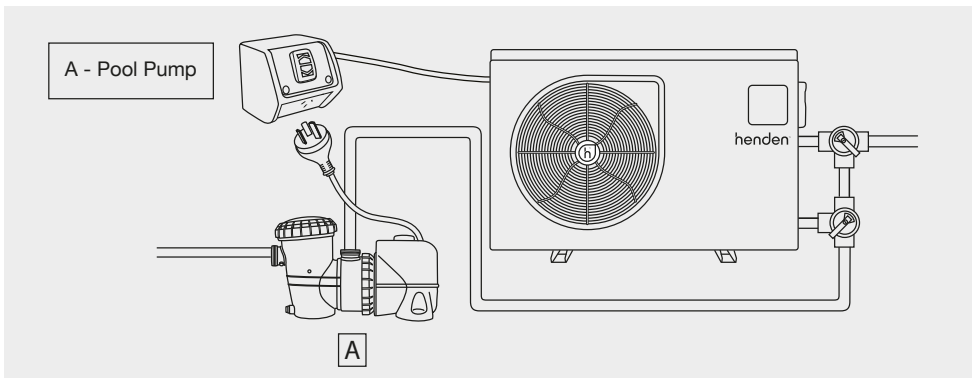

ALTERNATIVE INSTALLATION OPTIONS

- 5** The circulation pump can then be plugged into the power outlet connected to the Henden Inverter Heat Pump.

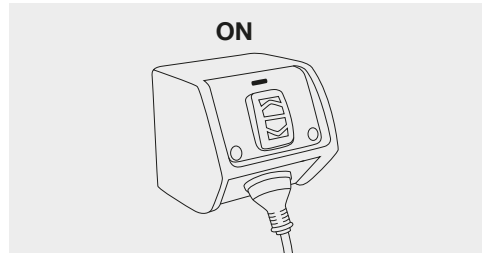

- 6** The Henden Inverter Heat pump will now use the inbuilt timers and temperature sensor to control the power to the outlet.
- If the pool reaches the set temperature, the Henden Inverter Heat Pump will switch off relay to stop the circulation pump.
 - While the timer is still active, the circulation pump will run for 2 minutes every hour to test the water temperature. If the temperature is 1 degree below the set point, the Henden Inverter Heat Pump will continue to run the circulation pump and start the heating process again.

Handy Tip: For optimal efficiency Henden recommends adjusting parameter #6 to 100. This will force the Henden Inverter Heat Pump to operate at 100% and reduce the time the circulation pump is required to run. To modify the parameters, refer to page 28.

ALTERNATIVE INSTALLATION OPTIONS

Flow activated with Chlorinator override controller

An onboard pump output relay can activate the main filtration pump by using it in combination with a “Chlorinator override controller”. This allows the Henden Inverter Heat Pump to run past the chlorinator timers and prevent over-chlorination when further heating is required.

Handy Tip: This set-up is best when only single pipework is available from pool and doesn't have individual heating pipework.

- 1 Access the electrical terminals using the steps from page 14.

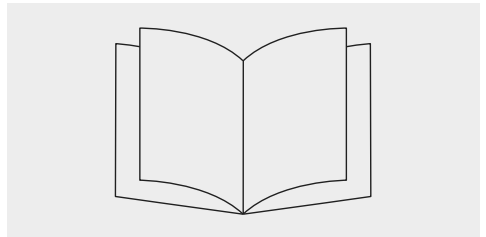

- 2 Locate the termination points labelled P1 and P2 from the on-board relay & connect the two-core cable from the Chlorinator override controller.

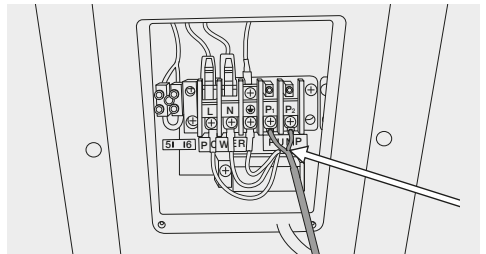

- 3 The Chlorinator override controller will then provide power to the circulation pump when it receives a signal from either the Chlorinator or the Henden Inverter Heat Pump.

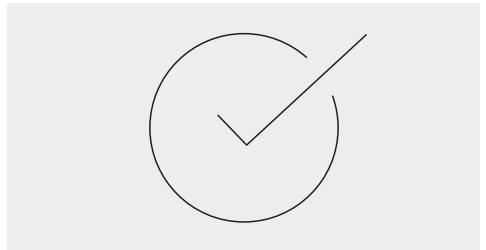

ALTERNATIVE INSTALLATION OPTIONS

Solar retro

The Henden Inverter Heat Pump can be used to replace existing solar heating systems. In some installations, this can be achieved using the existing solar pipework and pump.

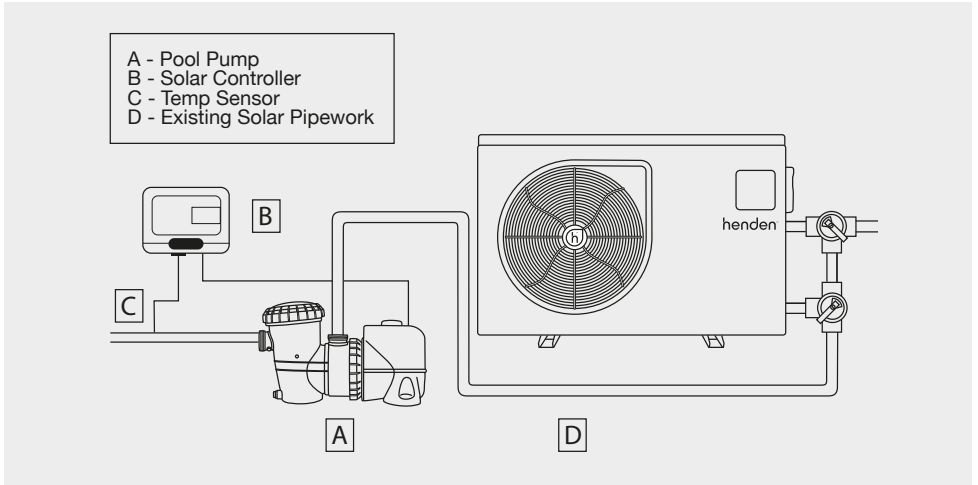

OPERATION

KEY FUNCTIONS:

Interpreting the keys

- 1** Mode key - Used to switch between Heating, Cooling and Auto modes.
- 2** Boost/Silence Mode key - Used to switch between boost and silence mode
- 3** Up key - used to increase/move up
- 4** Down key - used to decrease/move down
- 5** Timer key - Used to set timer
- 6** Power ON/OFF key - Used to Power ON/OFF.

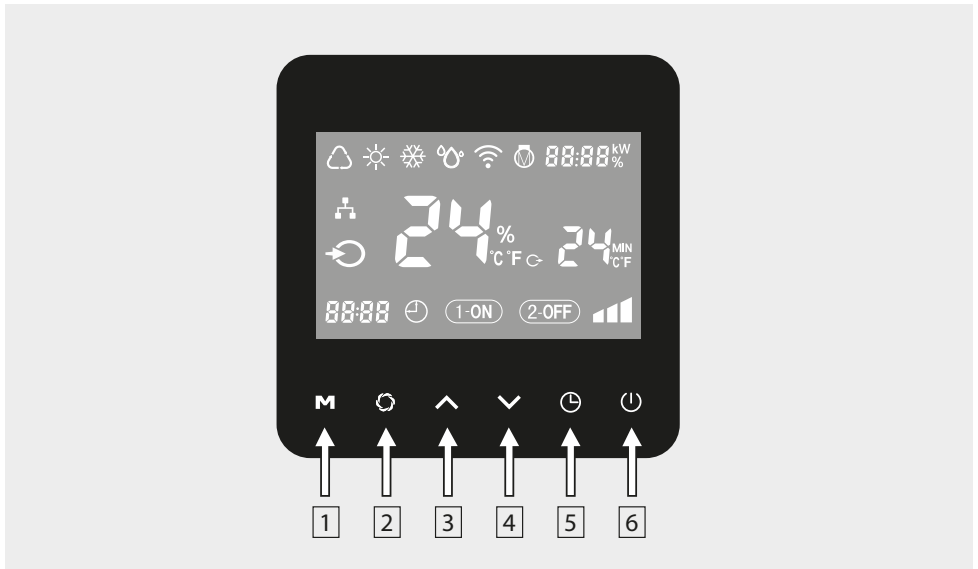

OPERATION

Interpreting the Symbols

- 1** Mode (Auto, Heating or Cooling)
- 2** Wi-Fi Connectivity
- 3** Clock
- 4** Timer
- 5** Boost/Silence mode
- 6** Inlet Temperature (Pool)
- 7** Celsius/Fahrenheit
- 8** Percentage/kW
- 9** Outlet Temperature/Minute

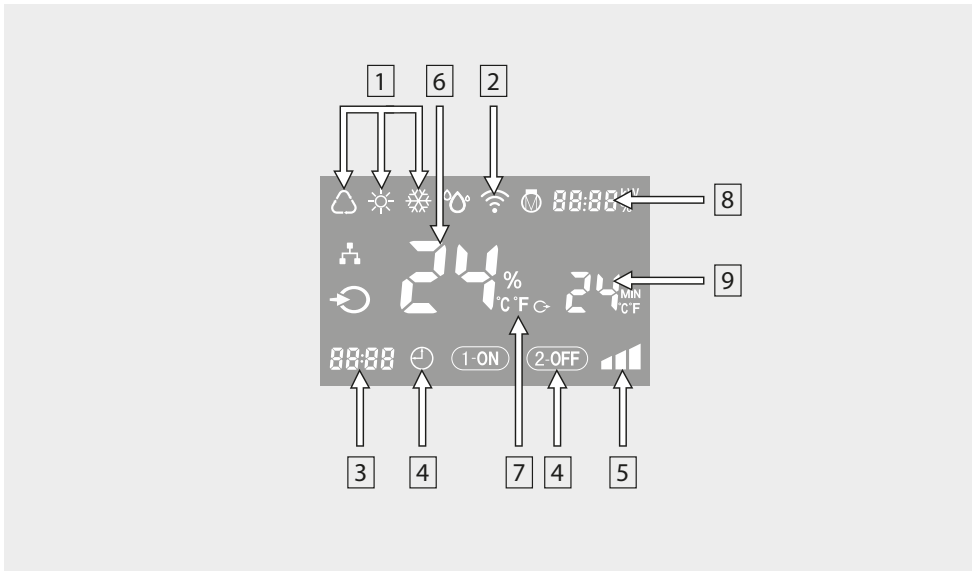

OPERATION

Turning power ON/OFF

Press the power key  to turn power ON/OFF.

Mode Selection

The Henden Inverter Heat Pump offers three modes: heating, cooling and auto.

Henden recommends using the default mode (heating). However, if required to select a different mode, quickly press the 'M' key .

Keep pressing the 'M' key  until you reach the desired mode.

Heating Mode is for a desired water temperature of 18-40°C.

Cooling Mode is for a desired water temperature of 8-30°C.

Auto Mode is for a desired water temperature of 8-40°C.

Inverter Technology

When the Henden Inverter Heat Pump approaches the set temperature within the circulation pump timers, the unit will first start to use the inverter technology to reduce input power to eventually stop when the set temperature has been maintained.





Boost/Silence Mode Selection

The Henden Inverter Heat Pump is also equipped with Boost & Silence Modes.

Press the Boost/Silence key to switch between boost mode or silence mode.

Setting the Temperature





The current set temperature can be found on the lower display of the control interface. To adjust the temperature, follow the steps below.

- 1 With the display on. Use the UP  and DOWN  arrows to select and display the desired set temperature.
- 2 The change between Celsius and Fahrenheit press and hold the UP  and DOWN  buttons simultaneously for 5 seconds.











OPERATION

Setting the clock

To set or adjust the clock follow the steps below or adjust the clock settings via the app.

- 1 Press the TIMER  key for 5 seconds to adjust the clock. The display will flash 88:88.
- 2 Use the UP  and DOWN  arrows to set the correct time.
- 3 Simultaneously press the UP  and DOWN  arrows to quit 'clock adjustment'. The adjustment will automatically quit after 30 seconds of no button press.

Setting the Timer

- 1 Press the TIMER  key for 10 seconds to edit timer setting. (The Timer  key and **1-ON** symbols will be flashing).
- 2 Press the TIMER  key again to select either single timer 'ON' or cycle timer **1-ON**.
- 3 Use the UP  and DOWN  arrows to set the 'on/ start' time.
- 4 Press the BOOST/SILENCE  key to confirm the on/ start time.
- 5 The 'OFF' symbol should now be flashing.
- 6 Press the TIMER  key to select either a single timer 'OFF' or cycle timer **2-OFF**.
- 7 Use the UP  and DOWN  arrows to set the 'off/ end' time.
- 8 Press BOOST/SILENCE  key to confirm the off/ end time and quit timer settings.

Note: The timer adjustment will automatically quit after 30 second of no key is pressed.

OPERATION

Cancelling Timers



To cancel the timer, press the TIMER  key for 10 seconds. Then without adjusting the settings, press the BOOST/SILENCE  key. This will cancel any set timer.

Auto Defrost and Manual Defrost

Auto Defrost:





- 1 If the Henden Inverter Heat Pump runs for extended periods in cold climates, it may experience a build of ice. If so, the unit will detect this and automatically go into defrost mode. When the Henden Inverter Heat Pump is defrosting the Heat mode icon will start flashing. When the defrosting is completed the Heat mode icon will be on continuously.

Manual Defrost:

- 1 When the unit is running, press BOOST/SILENCE  and DOWN  on the controller simultaneously and hold for 5 seconds.
- 2 When the 'Heat mode' icon is flashing, the defrost has started and will continue until the external coil temperature reaches a certain temperature adequate for continued operation.
- 3 When the 'Heat mode' symbol stops flashing the manual defrost has finished.

Note: the interval between two manual defrosts should be more than 30 minutes apart.

Checking the running status

- 1 To enter Running status checks, Press BOOST/SILENCE  for 5 seconds.
- 2 The Heat Pump will now display "CO" and its corresponding value.
- 3 Use the UP  and DOWN  arrows to change the status values.
- 4 Press BOOST/SILENCE  to quit 'Running Status Checking' mode; or it will quit automatically after 30 seconds of no operation.

OPERATION

Running status checking table:



SYMBOL	CONTENT	UNIT
C0	Inlet water temp	°C
C1	Outlet water temp	°C
C2	Ambient temp	°C
C3	Exhaust gas temp	°C
C4	Evaporator coil pipe temp	°C
C5	Return gas temp	°C
C6	Cooling coil pipe temp	°C
C9	Cooling plate temp	°C
C10	EEV opening angle	P
C11	DC fan speed	r/min

Parameters

Parameters should only be checked and adjusted by qualified persons as adjusting may cause damage and void warranty.

Checking Parameters:

- 1 Press BOOST/SILENCE and UP together for 5 seconds to enter 'parameter checking' status.
- 2 Parameter code NO. 'PO' and default parameter value '2' will display.
- 3 Press UP Key and DOWN Key to check the parameters.
Press POWER key to exit.

Modify parameters:

- 1 In 'parameter checking' status, press BOOST/SILENCE and UP together for 5 seconds to enter "parameter checking" status.
- 2 In 'parameter checking' state, press UP or DOWN to change the parameters value.
- 3 Press BOOST/SILENCE to confirm and return to the previous status.
- 4 Press POWER key to quit and return to the previous status.

OPERATION

Parameter table:

NO.	CONTENT	ADJUST RANGE	STEP LENGTH	DEFAULT
P0	Water flow direction	0: Continuation 1: Water temp control 2: time/water temp control	1	2
P1	Time setting (only available when the water pump running way is set to "2")	10 ~ 120 min	5 mins	60 mins
P2	Compressor continuously running time in defrosting mode	30 ~ 90 min	1 min	35 mins
P3	Defrosting start temp	-17 ~ 0°C	1°C	-7°C
P4	Defrosting running time	1 ~ 12 min	1 min	12 mins
P5	Defrosting quit temp	8 - 30°C	1°C	-13°C
P6	Single pump option	50-100	1	OFF
P10	Compressor speed control	0: Auto 1: Manual	1	0
P12	Electronic expansion valve overheat level (heating)	-10 - 20	1	3
P13	Electronic expansion valve overheat level (cooling)	-10 - 20	1	5
P14	Electronic expansion valve manual/auto	0: Auto 1: Manual	1	0
P15	Electronic expansion valve opening setting (heating)	30-240C	2P	175
P16	Electronic expansion valve opening setting (cooling)	30-240C	2P	175
P20	Power off memory function	0: NO 1: YES	1	1

APP FUNCTIONALITY

For app functionality, it is crucial that there is a strong Wi-Fi signal at the site of installation.

Handy Tip: Make sure to switch off your data package on your phone prior pairing the heater, Mobile data can interrupt the connection process in some cases therefore failing to connect the unit.

Handy Tip: Your phone should be displaying full Wi-Fi strength with -50 DB > to ensure that you have enough signal strength for the heater to connect.

APP FUNCTIONALITY

The Invergo App can be used to control and monitor your Henden Inverter Heat Pump via Wi-Fi. To set up the Invergo App, follow the steps below:

- 1 Open Apple Apps or Google Play and download Invergo.



- 2 Open Invergo and follow the prompts to create an account.

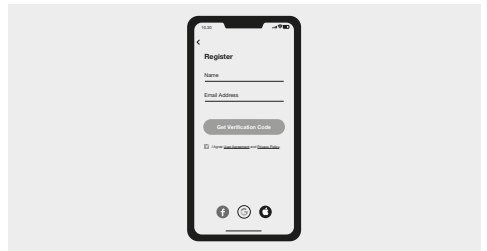

- 3 Press and hold the power button on the Inverter Heat Pump for 3 seconds to activate Wi-Fi pairing.

Open the app and select Add a Device.

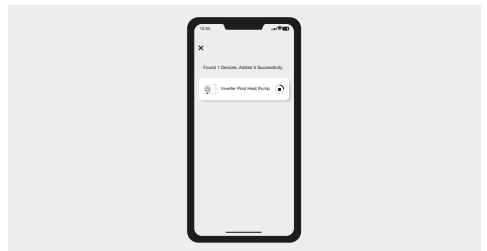

- 4 Follow the prompts in the App to set and monitor the pool water temperature.



APP FUNCTIONALITY

App display:



SPECIFICATIONS

Performance						
Heater Model	9kW	14kW	17kW	20kW	24kW	28kW
Performance at conditions: Air 27°C / Water 26°C / Humidity 80%						
Heating capacity (kW)	9.0	14.2	17.0	20.1	24.0	28.0
COP range	10.6 - 5.7	11 - 6	10.8 - 5.9	10.8 - 6	10.8 - 6.1	11.0 - 6.3
Performance at conditions: Air 15°C / Water 26°C / Humidity 70%						
Heating capacity (kW)	6.2	9.8	11.5	13.8	16.0	19.5
COP range	6.2 - 4.1	6.6 - 4.3	6.3 - 4.1	6.4 - 4.0	6.4 - 4.3	6.5 - 4.4
Performance at conditions: Air 35°C / Water 28°C / Humidity 80%						
Cooling capacity (kW)	3.4	5.4	6.1	7.7	8.8	10.8

Technical Specifications						
Heater Model	9kW	14kW	17kW	20kW	24kW	28kW
Power supply	230V 1Ph	230V 1Ph	230V 1Ph	230V 1Ph	230V 1Ph	230V 1Ph
Rated input power (kW)	0.30-1.51	0.46-2.28	0.56-2.80	0.69-3.45	0.74-3.72	0.89-4.43
Rated input current (A)	1.30-6.57	2.00-9.91	2.44-12.17	3.00-15.00	3.22-16.17	3.87-19.3
Electrical connection	10A	15A	Hardwired	Hardwired	Hardwired	Hardwired
Maximum input current (A)	7.7	11.6	14.2	17.5	18.9	22.5
Casing	ABS	ABS	ABS	ABS	ABS	ABS
Water Connection (mm)	50/48.3	50/48.3	50/48.3	50/48.3	50/48.3	50/48.3
Sounds pressure 1m dB(A)	20-45	35-70	40-75	50-90	60-110	65-120
Ideal water flow (L/min)	50	75	80	100	140	180
Operating air temperature	0-43°C	0-43°C	0-43°C	0-43°C	0-43°C	0-43°C

Dimensions						
Heater Model	9kW	14kW	17kW	20kW	24kW	28kW
Length x width x height	903 x 339 x 654mm	903 x 339 x 654mm	991 x 347 x 654mm	991 x 347 x 755mm	991 x 347 x 755mm	1122 x 415 x 958mm
Weight	46kg	49kg	60kg	68kg	68kg	90kg

DIMENSIONS

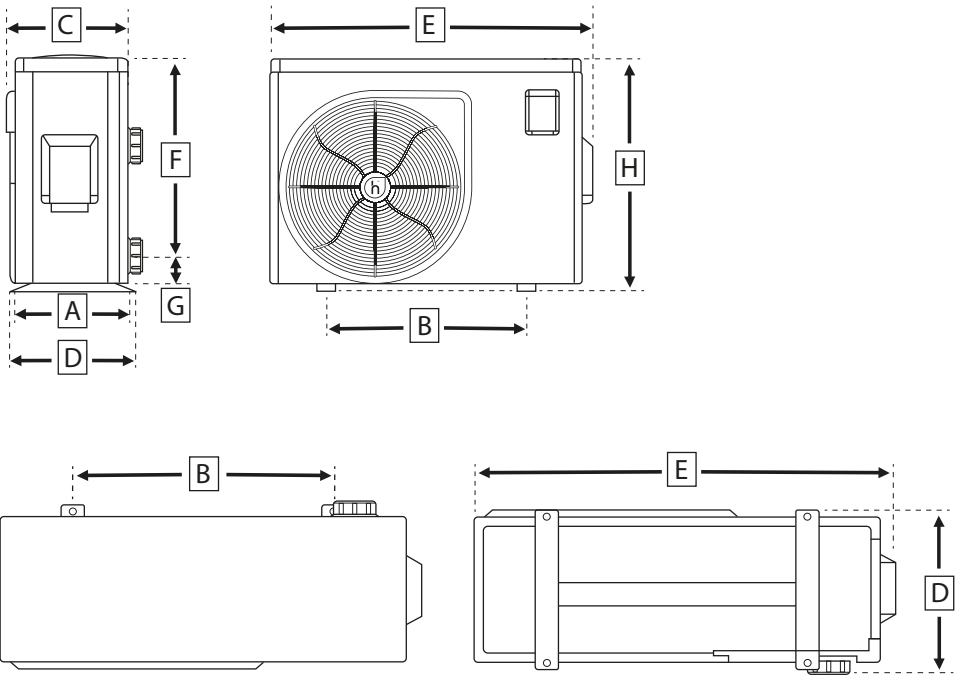

Dimensions								
Model Size	A	B	C	D	E	F	G	H
9kW	324mm	560mm	339mm	349mm	903mm	250mm	74mm	654mm
14kW	324mm	560mm	339mm	349mm	903mm	320mm	74mm	654mm
17kW	324mm	590mm	347mm	349mm	991mm	350mm	74mm	654mm
20kW	324mm	590mm	347mm	349mm	991mm	390mm	74mm	755mm
24kW	324mm	590mm	347mm	349mm	991mm	460mm	74mm	755mm
28kW	395mm	720mm	415mm	420mm	1122mm	640mm	74mm	958mm

MAINTENANCE

WHEN	WHAT ARE YOU LOOKING FOR?	HOW CAN YOU FIX IT?
Weekly	Check around the unit for leaves/debris or signs of flooding.	Remove any debris that is restricting air circulation around the Henden Inverter Heat Pump. If in a flood prone location, rectify.
Quarterly	Check all gaskets	Isolate and turn off the Henden Inverter Heat Pump. Remove all gaskets and turn over. You can also apply a silicon-based grease to extend the life. If dry, then contact your local pool professional to replace.
	Check for any insects/ants etc.	It is a good practice to use a good quality surface spray around your equipment. Make sure all units are turned off and then spray around all units to eliminate any insect/ants etc.
	Check for any leaks	If you notice any water leaking from the heat pump, check gaskets first and reseal. If continues, contact your local pool professional to assess and rectify.
Annually	Clean the evaporative coil and fan	Isolate and turn off the Henden Inverter Heat Pump. Use a soft cloth with water containing a small amount of household detergent to carefully clean the entire outside of the unit, especially the evaporative coils and fan.

WINTERISING

If you live in a climate where your temperature is low enough to freeze the pool, it is important to winterise your Inverter Heat Pump. Failure to follow these steps could result in water freezing inside the unit, and causing potential damage.

To prepare your heat pump for freezing conditions:

- 1** Turn off the power supply to the Inverter Heat Pump.
- 2** If the heat pump is positioned below the pool water level, ensure the inlet and outlet valves are turned off.
- 3** Remove the inlet unions and drain water out of the Invert Heat Pump.
- 4** When the water is completely drained, replace the inlet union fitting.

TO DE-WINTERISE YOUR INVERTER HEAT PUMP

Once the freezing conditions have subsided and you are ready to restart your Inverter Heat Pump, turn the valves back to on, turn power onto the Henden Inverter Heat Pump and restart.

STORAGE

If not in use for long periods of time (e.g. colder months), discharge all water in the Henden Inverter Heat Pump, including the water at the bottom. This prevents water from freezing in the Inverter Heat Pump and potentially causing damage.

TROUBLESHOOTING

Troubleshooting should be carried out by a qualified pool professional.

FAILURE	CAUSE	REMEDY
The Inverter Heat Pump is not running.	There has been a power outage.	Wait for power to return. Once the supply is back online, the unit will begin to operate.
	The power switch is off.	Switch on the power source.
	The fuse has blown.	If the fuse has blown, contact a qualified electrician to repair the fuse.
	The breaker is off.	Turn the breaker on.
The heat produced is insufficient, but the fan is running.	The evaporator is blocked.	Remove the obstacles.
	The air outlet is blocked.	Review the maintenance and ventilation requirements in this manual.
	There is a three minute start delay.	Review the maintenance and ventilation requirements in this manual.
The display is on, but the unit isn't heating.	The temperature is set too low.	Set a higher heating temperature.

ERROR CODES

ERROR CODE	TYPE OF FAULT	CAUSE	REMEDY
P01	Inlet Temp. Sensor Fault	Sensor is broken or short circuit	Check or change the temp. Sensor
P02	Outlet Temp.Sensor Fault	Sensor is broken or short circuit	Check or change the temp. Sensor
P04	Ambient Temp.Sensor Fault	Sensor is broken or short circuit	Check or change the temp. Sensor
P05	Coil Temp.Sensor Fault	Sensor is broken or short circuit	Check or change the temp. Sensor
P07	Suction Temp.Sensor Fault	Sensor is broken or short circuit	Check or change the temp. Sensor
P081	Discharge Temp. Sensor Fault	Sensor is broken or short circuit	Check or change the temp. Sensor
E01	High Pressure Prot.	Poor water flow or ventilation The high-pressure switch is broken	Check water flow and ventilation Check the pressure switch and cold circuit
E02	Low Pressure Prot.	Low pressure protection	Check the pressure switch and cold circuit
E03	Flow Switch Prot.	No water/little water in water system	Check the pipe water flow and water pump
E07	Anti-freezing Prot	Water flow is not enough	Check the pipe water flow and whether water system is blocked or not
E19	Primary Anti-freezing Prot.	The ambient temp. Is low	Make sure that proper ventilation is provided to the unit
E29	Secondary Anti-freezing Prot.	The ambient temp. Is low	
E06	Inlet and outlet temp. too big	Water flow is not enough and low differential pressure	Check the pipe water flow and whether water system is jammed or not
Non	Low temperature protection	The environment temp. is low	
E051	Comp. Overcurrent Prot.	Compressor running above normal running conditions	Check water flow and ventilation is correct Check incoming power
P082	Exhaust Air over Temp Prot.	The compressor is overload	Check whether the system of the compressor running normally
E08	Communication Fault	Communication failure between wire controller and mainboard	Check the wire connection between remote wire controller and main board

ERROR CODES

ERROR CODE	TYPE OF FAULT	CAUSE	REMEDY
P09	Antifreeze Temp. Sensor Fault	antifreeze temp sensor is broken or short circuited	check and replace this temp sensor
E05	Waterway Anti-freezing Prot.	water temp. .or ambient temp. is too low	
F051	EC fan feedback Fault	There is something wrong with fan motor and fan motor stops running	Check whether fan motor is broken or locked or not
PP	Pressure sensor Fault	The pressure Sensor is broken	Check or change the pressure Sensor or pressure
F031	Fan Motor1 Fault	1. Motor is in locked-rotor state 2. The wire connection between DC-fan motor module and fan motor is in bad contact	Change a new fan motor Check the wire connection and make sure they are in good contact
TP	Low AT Protection	Ambient temp is too low	

FREQUENCY CONVERSION BOARD FAULT

ERROR CODE	TYPE OF FAULT	CAUSE	REMEDY
F01	Drv1 MOP alarm	MOP drive alarm	Recovery after the 150s
F02	Inverter offline	Frequency conversion board and main board communication failure	Check the communication connection
F03	IPM protection	IPM modular protection	Recovery after the 150s
F04	Comp. Driver Failure	Lack of phase, step or drive hardware damage	Check the measuring voltage check frequency conversion board hardware
F05	DC Fan Fault	Motor current feedback open circuit or short circuit	Check current return wires connected motor
F06	IPM Overcurrent	IPM Input current is large	Check and adjust the current measurement
F07	Inv. DC Overvoltage	DC bus voltage>DC bus over-voltage protection value	Check the input voltage measurement
F08	Inv. DC Less voltage	DC bus voltage<DC bus over-voltage protection value	Check the input voltage measurement
F09	Inv. Input Less voltage	The input voltage is low, causing the input current is high	Check the input voltage measurement
F10	Inv. Input Overvolt	The input voltage is too high, more than outage protection current RMS	Check the input voltage measurement
F11	Inv. Sampling Volt.	The input voltage sampling fault	Check and adjust the current measurement
F12	Comm. Err DSP-PFC	DSP and PFC connect fault	Check the communication connection
F26	Input Over Cur.	The equipment load is too large	
F27	PFC fault	The PFC circuit protection	Check the PFC switch tube short circuit or not
F15	IPM Over heating	The IPM module is overheat	Check and adjust the current measurement
F16	Weak Magnetic Warn	Compressor magnetic force is not enough	
F17	Inv. Input Out Phase	The input voltage lost phase	Check and measure the voltage adjustment
F18	IPM Sampling Cur.	IPM sampling electricity is fault	Check and adjust the current measurement
F19	Inv. Temp. Probe Fail	Sensor is short circuit or open circuit	Inspect and replace the sensor
F20	Inverter Overheating	The transducer is overheat	Check and adjust the current measurement

FREQUENCY CONVERSION BOARD FAULT

ERROR CODE	TYPE OF FAULT	CAUSE	REMEDY
F22	Inv. Overheating Warn	Transducer temperature is too high	Check and adjust the current measurement
F23	Comp. OverCur. Warn	Compressor electricity is large	The compressor over-current protection
F24	Input Over Cur. Warn	Input current is too large	Check and adjust the current measurement
F25	EEPROM Error Warn	MCU error	Check whether the chip is damaged Replace the chip
F28	V15V over/ undervoltage fault	The V15V is overload or undervoltage	Check the V15V input voltage in range 13.5v~16.5v or not
F032	Fan Motor2 Fault	1. Motor is in locked-rotor state 2. The wire connection between DC-fan motor module and fan motor is in bad contact	Change a new fan motor Check the wire connection and make sure they are in good contact
E081	Communication Fault (speed control module)	Speed control module and main board communication fail	Check the communication connection

EXPLODED DIAGRAM

9kw/14kw/17kw/20kw

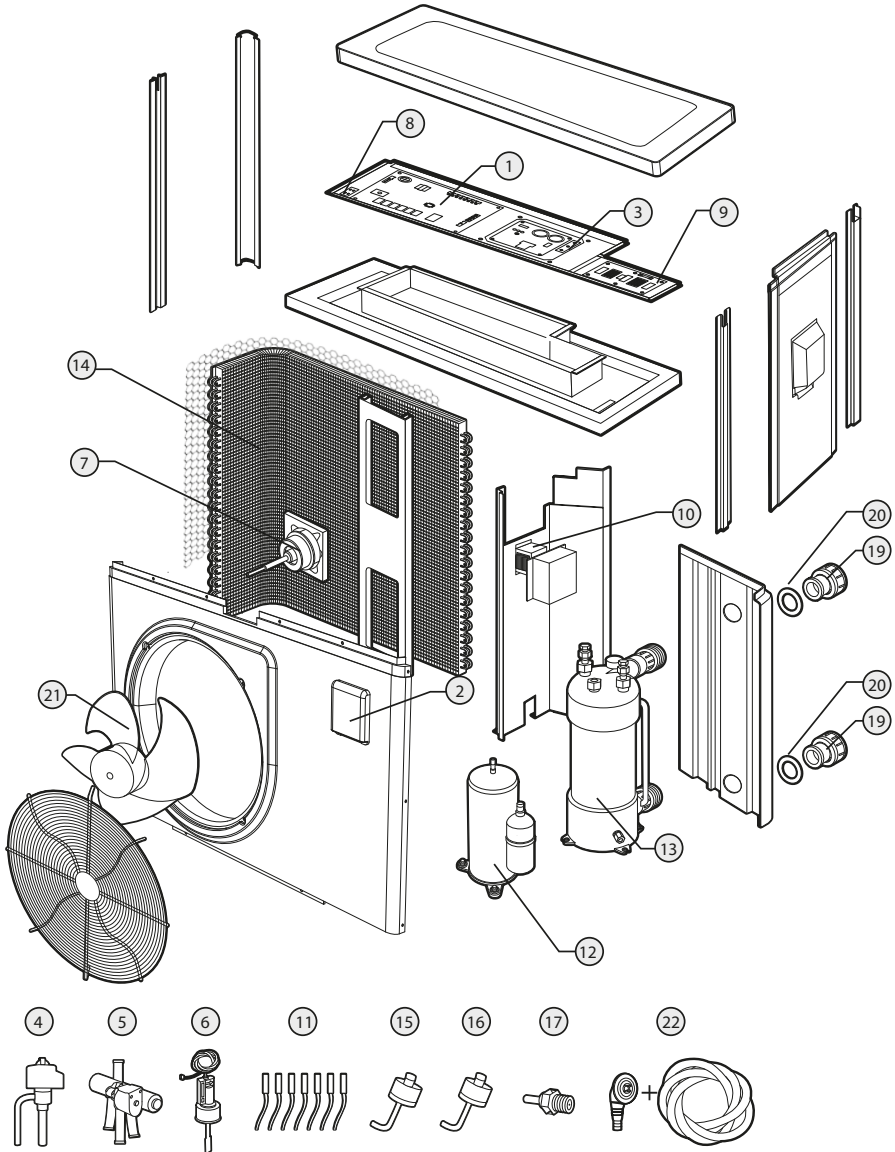

SPARE PARTS

9kw/14kw/17kw/20kw

NO.	SPARE PARTS
1	PC board (Heat & Cool)
2	LED controller (Heat & Cool)
3	Inverter board
4	Electronic expansion valve
5	4-way valve
6	Water flow switch
7	Fan motor
8	Capacitor
9	Power filter board
10	Reactor
11	Sensors(full set)

NO.	REFRIGERATE SYSTEM SPARE PARTS
12	Compressor
13	Titanium heat exchanger (Heat & Cool)
14	Evaporator
15	High pressure protection switch
16	Low pressure protection switch
17	Low pressure valve
18	Liquid accumulator

NO.	OTHER SPARE PARTS
19	Water union (48.3mm)
20	Water union gasket
21	Fan Blade
22	Drainage kit
23	Fan shroud

EXPLODED DIAGRAM

24kw/28kw

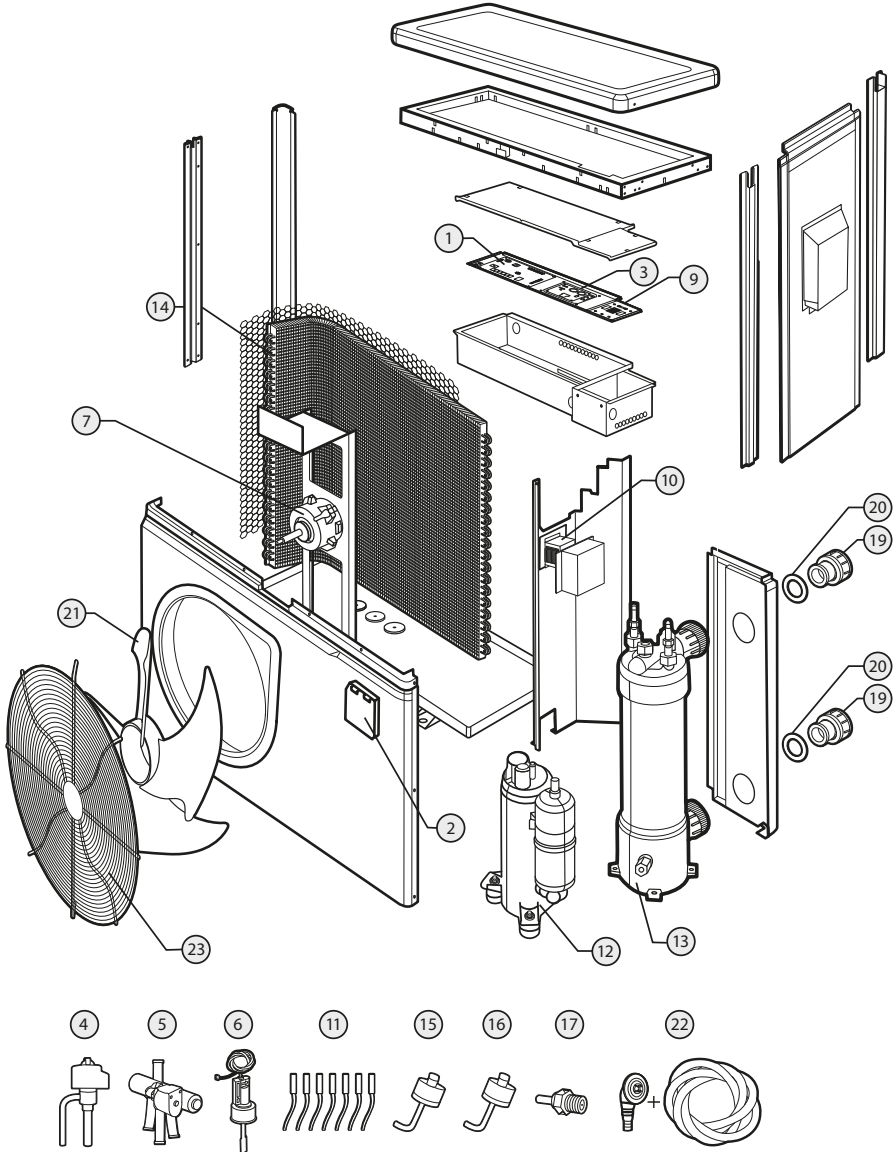

SPARE PARTS

24kw/28kw

NO.	SPARE PARTS
1	PC board (Heat & Cool)
2	LED controller (Heat & Cool)
3	Inverter board
4	Electronic expansion valve
5	4-way valve
6	Water flow switch
7	Fan motor
8	Capacitor
9	Power filter board
10	Reactor
11	Sensors(full set)

NO.	REFRIGERATE SYSTEM SPARE PARTS
12	Compressor
13	Titanium heat exchanger (Heat & Cool)
14	Evaporator
15	High pressure protection switch
16	Low pressure protection switch
17	Low pressure valve
18	Liquid accumulator

NO.	OTHER SPARE PARTS
19	Water union (48.3mm)
20	Water union gasket
21	Fan Blade
22	Drainage kit
23	Fan shroud

WARRANTY

HENDEN™ REPAIR OR REPLACEMENT GUARANTEE

Our goods come with guarantees that cannot be excluded under the Australian Consumer Law. You are entitled to a replacement or refund for a major failure and compensation for any other reasonably foreseeable loss or damage. You are also entitled to have the goods repaired or replaced if the goods fail to be of acceptable quality and the failure does not amount to a major failure. Should you experience any difficulties with your Henden product, we suggest in the first instance that you contact the installer of the product or your local Reece Irrigation & Pools branch. Alternatively you can phone Henden. On receipt of your claim, Henden will seek to resolve your difficulties, if the product is faulty or defective, advise you on how to have your Henden product repaired, obtain a replacement or a refund. Henden does not cover normal wear or tear, or damage resulting from misuse or negligent handling, improper use for which the product was not designed or advertised, failure to properly follow the provided installation and operating instructions, failure to carry out maintenance, corrosive or abrasive water or other liquid, lightning or high voltage spikes, or unauthorized persons attempting repairs. Where applicable, your Henden product must only be connected to the voltage shown on the nameplate. Henden does not cover freight or any other costs incurred in making a claim. Please retain your receipt as proof of purchase; you **MUST** provide evidence of the date of original purchase when making a claim. Henden shall not be liable for any loss of profits or any consequential, indirect or special loss, damage or injury of any kind whatsoever arising directly or indirectly from Henden products. Should your Henden product require repair or service after the guarantee period; contact your nearest Reece Irrigation & Pools branch or phone the number below.

For a complete list of Reece Irrigation & Pools branches visit our website **reece.com.au/storefinder** or contact:

Technical and after sales support:

1300 HENDEN (1300 436 336)

Mailing/manufacture address:

Madimack
Suite 1B
Level 31/100 Miller St
North Sydney NSW 2060

henden™

