

MODELS

ECF29I50 ECF19I50

ECF29I60 ECF19I60



Electric Continuous Flow Water Heater

Operation & Installation Manual

Rinnai

Congratulations on the purchase of your Rinnai Electric Continuous Flow Water Heater. We trust you will have many years of comfort and satisfaction from your appliance.



BEFORE USING THIS APPLIANCE

Before proceeding with the operation or installation read this manual thoroughly and gain a full understanding of the appliance, to ensure safe and correct use.

This appliance must be installed in accordance with:

- Manufacturer's Installation Instructions
- Current AS/NZS 3000 & AS/NZS 3500
- Plumbing Code of Australia (PCA) or New Zealand Building Code
- Local Regulations and Municipal Building Codes including local OH&S requirements

This appliance must be installed, maintained and removed by an Authorised Person.

For continued safety of this appliance it must be installed and maintained in accordance with the manufacturer's instructions.



This Appliance complies
with current AS 3498
LIC. WM-032245

OPERATION TABLE OF CONTENTS

Warnings & Important Information	4
Before Using This Appliance	4
Regulatory Information	4
Notice to Victorian Consumers	4
Mandatory Inspection Prior to Installation or Use	4
Scald Hazards	5
Operational Safety Information	6
About Your Heater	8
Maximum Delivery Temperature	8
Temperature Control	8
Features & Benefits	8
Operation	9
Control Panel Console Operation	9
Maintenance	11
Turning Water Heater ‘Off’	11
Turning Water Heater ‘On’	11
Cleaning and Inspection	11
Draining	11
Trouble Shooting	12
Error Codes	12
Save a Service Call	12
Service	13
Installation Table of Contents	14
Contacts	28

WARNINGS & IMPORTANT INFORMATION



BEFORE USING THIS APPLIANCE

Before proceeding with the operation or installation read this manual thoroughly and gain a full understanding of the appliance, to ensure safe and correct use.

Always comply with the following precautions to avoid dangerous situations and to ensure optimum performance.

Failure to carefully read and follow all instructions in this manual can result in equipment malfunction, property damage, personal injury and/or death.

DANGER: Indicates an imminently hazardous situation which, if not avoided, will result in personal injury or death.

WARNINGS: Indicates a potentially hazardous situation which, if not avoided, could result in personal injury or death.

CAUTIONS: Indicates a potentially hazardous situation which, if not avoided, could result in minor or moderate injury or damage to the appliance. It may also be used to alert against unsafe practices.



REGULATORY INFORMATION

This appliance **MUST** be installed in accordance with these instructions and all regulatory requirements which exist in your area including those in relation to manual lifting, working at heights and on roofs. Applicable publications and regulations will include:

- AS/NZS 3500 National Plumbing and Drainage
- AS/NZS 3000 Wiring rules
- Plumbing Code of Australia (PCA)
- Building Codes of Australia (BCA) or New Zealand Building Code
- Local Occupational Health and Safety (OH&S) regulations
- Local Regulations and Municipal Building Codes

This appliance **MUST** be installed, commissioned and serviced correctly by an appropriately licensed tradesperson. The installation of water and electricity must conform to local regulations.

For continued safety of this appliance it **MUST** be installed, operated and maintained in accordance with the manufacturer's instructions.

Please keep this instruction booklet in a safe place for future reference.

All dimensions referred to in these instructions are in millimetres, unless otherwise specified.

Notice to Victorian Consumers

This appliance **MUST** be installed by a person licensed with the Victorian Building Authority. Only a licensed person will have insurance protecting their workmanship. So make sure you use a licensed person to install this appliance and ask for your Compliance Certificate.

For further information contact the Victorian Building Authority on 1300 815 127.



MANDATORY INSPECTION PRIOR TO INSTALLATION OR USE

Immediately report any damage or discrepancies to the Supplier of the appliance. This appliance was inspected and tested at the time of manufacture and packaging, and released for transportation without known damage. Upon receipt, inspect the exterior for evidence of rough handling in shipment. Ensure that the appliance is labelled correctly for the electrical supply, and/or other services it is intended to be connected to. For safety and warranty purposes, appliances that may be damaged or incorrect **MUST NOT** be installed or operated under any circumstances. Installation of damaged or incorrect appliances may contravene local government regulations. Rinnai disclaims any liability or responsibility whatsoever in relation to the installation or operation of damaged or incorrect appliances.

SCALD HAZARDS



Hot water can cause scalding.

Those most at risk are children and disabled, elderly and infirm persons.

Feel water temperature before bathing or showering.

Scalds can occur when children are exposed directly to hot water when they are placed into a bath which is too hot.

Rinnai have water heater models which limit the delivery temperature to 50°C which significantly reduces the scald hazard.

Always.....

Test the water temperature with your elbow before placing your child in the bath, also carefully feel water temperature before bathing or showering yourself.

Supervise children whenever they are in the bathroom or near other sources of hot water.

Ensure any hot water taps are closed firmly after use.

Consider.....

Installing child proof tap covers or child resistant taps (both approaches will prevent a small hand being able to turn on the tap).

Installing tempering valves or thermostatic mixing valves which reduce the hot water temperature delivered to the taps. Your local plumbing authority may already require that these be fitted. Contact your installer or local plumbing authority if in doubt.

Never.....

Leave a toddler in the care of another child. They may not understand the need to have the water temperature set at a safe level.



Operational Safety Information



This appliance is **NOT** intended for use by persons (including children) with reduced physical, sensory or mental capabilities, or lack of experience and knowledge, unless they have been given supervision or instruction concerning use of the appliance by a person responsible for their safety. Children **MUST** be supervised to ensure that they **DO NOT** play with the appliance.

DO NOT operate this system before reading the manufacturer's instructions.

Take care when opening or unpacking this appliance. Failure to do so may result in serious injury or product failure.

DO NOT modify the electrical wiring of this appliance. If the control power wiring is damaged or deteriorated then it must be replaced by an authorised person. Failure to do so may result in electric shock, fire, serious injury or product failure.

Removal of the access covers of the water heater will expose 415V 3 phase electrical supply. Access covers **MUST ONLY** be removed by an authorised person.

Care should be taken not to touch the pipe work as it may be **HOT!**

This appliance is **NOT** suitable for use as a domestic spa pool or swimming pool heater.

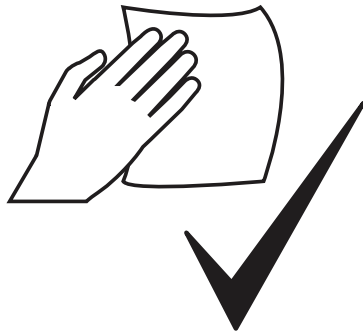
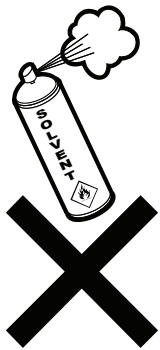

Max. 42°C

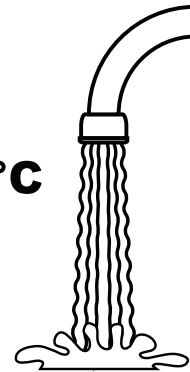

To clean your appliance use a soft damp cloth with a mild detergent.

DO NOT use solvents!

While hot water outlets are open the set temperature may be lowered. However, they cannot then be raised above 42°C.

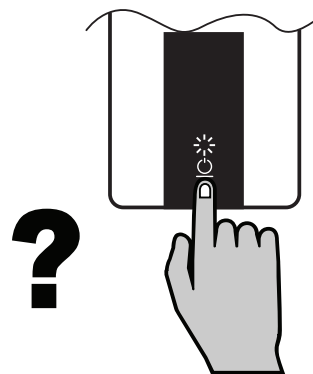
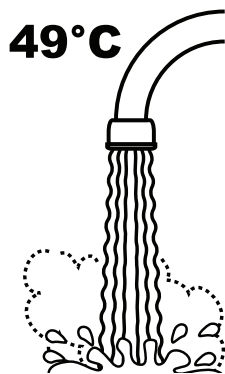
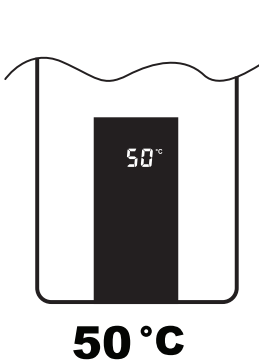

Depending on the weather conditions and the length of the pipe between the hot water unit and the outlet in use, there may be a variation between the temperatures displayed at the water controller(s) and the temperature of the water at the outlet.

There is no need to turn the appliance off after use. The appliance will be on standby mode automatically.

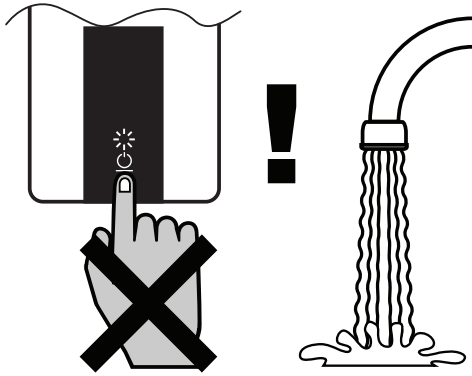

DO NOT push the On/Off button on the appliance when the water heater is on as this will turn off the water heater.

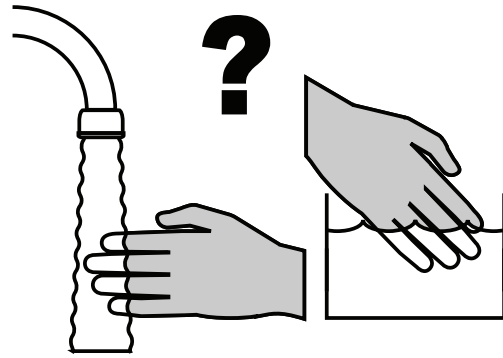

Always check water temperature carefully before use. Refer to the **"SCALD HAZARDS" ON PAGE 5** for important safety information.

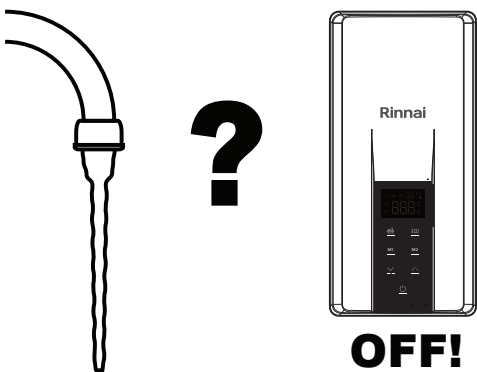

At low water flows, the hot water unit may extinguish without warning. Opening the tap further will restart the heating appliance.



DO NOT Spray aerosols in the vicinity of this appliance while it is in operation.

DO NOT use or store flammable materials in or near this appliance.

DO NOT place articles on or against this appliance.

DO NOT modify this appliance.

DO NOT store pool chemicals near this appliance.

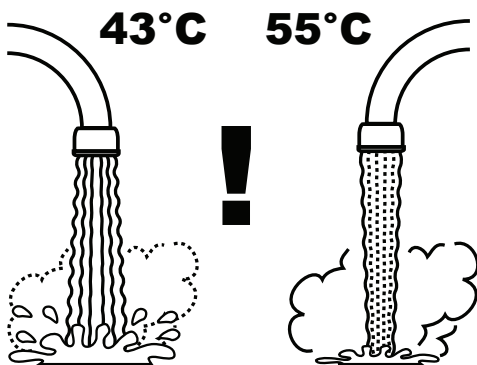

The delivered water temperature is controlled automatically. The water flow will vary depending on the delivery temperature selected and the ambient water temperature.

ABOUT YOUR HEATER

Congratulations on purchasing the latest technology temperature controlled Rinnai electric continuous flow water heater.

Rinnai electric continuous flow water heater products operate automatically. The opening of any hot water tap will automatically start the appliance. Once water is flowing through the appliance, the heating elements become energised to heat the water immediately.

The flowing water will be supplied up to the maximum temperature that the unit is capable or set to supply. As with all water heaters, cold water may need to be added to reduce the temperature to the desired level. When the hot water tap is closed and water ceases to flow through the appliance, the heating elements stop heating automatically.

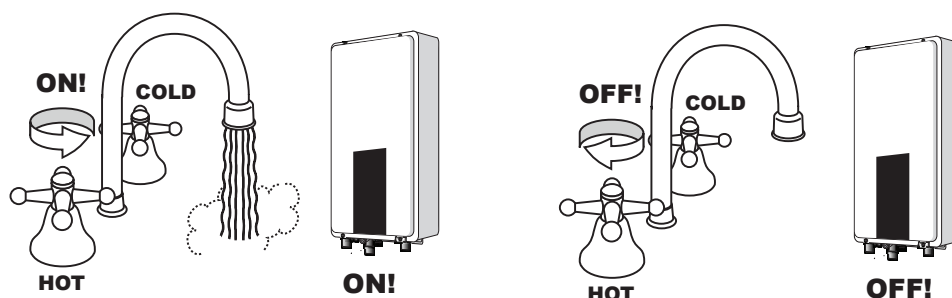

MAXIMUM DELIVERY TEMPERATURE

Rinnai electric continuous flow water heaters are factory pre-set to various maximum delivery temperatures (50°C or 60°C) depending on model and their intended application

Temperature Control

This water heater allows precise temperature control by the user. When used correctly, the hot water unit will adjust to supply at the selected temperature, even when the water flow is varied, or more than one tap is in use.

The temperature control range is 30 - 50 (50°C appliance*), and 30 - 60°C (60°C appliance).

* These appliances deliver water not exceeding 50°C in accordance with AS3498.

FEATURES & BENEFITS





- The Rinnai electric continuous flow water heater products **NEVER RUN OUT** of hot water. While suitable electricity and water supplies are connected, hot water is available whenever hot water taps are open.
- Built into the main micro-processor is the facility to **LIMIT THE MAXIMUM TEMPERATURE** of the hot water supplied. The water temperature may be limited to various values. This is particularly useful when the hot water unit is installed where young children or the infirm may be using the hot water.
- The Rinnai electric continuous flow water heater products are **COMPACT**, saving both floor and wall space.
- The delivery temperature of hot water is **CONSTANTLY MONITORED** by **BUILT-IN SENSORS**.
- The control panel console lights up automatically when the hot water tap is opened and goes out after 60 seconds when the tap is closed, and is then in standby mode.



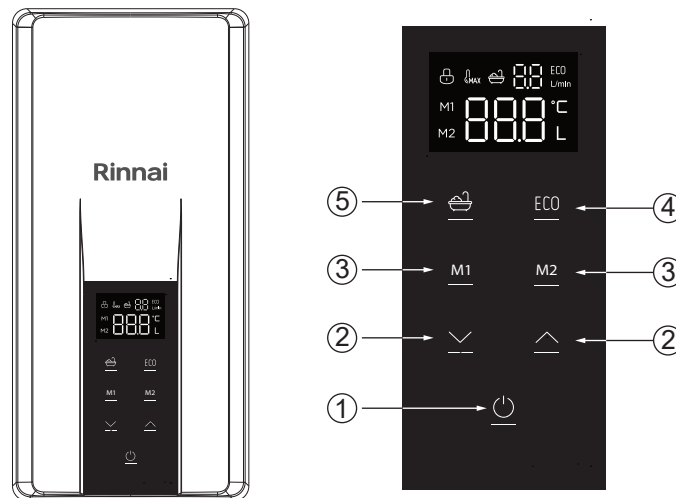

Model	Description	Max Temperature	Rated Power*
ECF19I50	Rinnai Electric CFWH 19.4kW 50°C	50°C	19.4kW@415V AC 3 Phase
ECF19I60	Rinnai Electric CFWH 19.4kW 60°C	60°C	19.4kW@415V AC 3 Phase
ECF29I50	Rinnai Electric CFWH 28.5kW 50°C	50°C	28.5kW@415V AC 3 Phase
ECF29I60	Rinnai Electric CFWH 28.5kW 60°C	60°C	28.5kW@415V AC 3 Phase

*See Table 1, page 26 for rated power in New Zealand at 400 V.

CONTROL PANEL CONSOLE OPERATION



	<p>① ON / OFF button</p> <p>Press the 'ON/OFF' button on the Control Panel to turn the appliance on or off.</p>				
 	<p>② Temperature adjustment buttons</p> <p>Press the 'UP' or 'Down' button to adjust the water temperature.</p> <p>Select the desired temperature using the temperature adjustment 'UP' or 'Down' button until the required temperature is displayed on the screen.</p> <p>To operate the hot water unit, open any hot water tap. It will automatically start the appliance and provide hot water. The display screen shows the water temperature (°C) and flow rate (L/min)</p> <table border="1" data-bbox="512 1182 1195 1263"> <tr> <td>Temperature range</td> <td>30~60°C for 60°C appliance</td> </tr> <tr> <td></td> <td>30~50°C for 50°C appliance</td> </tr> </table> <p>For hygiene in sanitary areas such as bathrooms, the suggested temperature should be 37°C ~ 43°C. The above is a recommendation only, as you may find higher or lower temperatures more comfortable. However, maintaining lower temperatures also helps to save energy.</p> <p>For safety reasons, the set temperature cannot be raised above 43°C until all hot water taps are closed.</p> <div data-bbox="261 1480 1458 1585" style="background-color: #e0e0e0; padding: 5px;"> <p> NOTE While hot water outlets are open, for safety, the temperature CANNOT be raised above 43°C until all hot water taps are closed.</p> </div>	Temperature range	30~60°C for 60°C appliance		30~50°C for 50°C appliance
Temperature range	30~60°C for 60°C appliance				
	30~50°C for 50°C appliance				
<p>M1</p> <hr/> <p>M2</p> <hr/>	<p>③ M1 / M2 buttons</p> <p>M1 and M2 are factory preset at temperatures for quick change of set points.</p> <table border="1" data-bbox="560 1720 1147 1765"> <tr> <td>M1 is preset at 38°C</td> <td>M2 is preset at 42°C</td> </tr> </table> <p>Press M1 or M2 to set the appliance to preset mode. To exit the preset mode, press M1 or M2 button again.</p> <p>It allows user to adjust / save your M1 or M2 preset temperature. Press and hold M1 or M2 button for 3 seconds, the temperature display on the display panel will flash. Then adjust the temperature set point by pressing 'UP' or 'Down' button. Press M1 or M2 button to exit the mode, the selected temperature will now be set and saved.</p>	M1 is preset at 38°C	M2 is preset at 42°C		
M1 is preset at 38°C	M2 is preset at 42°C				

	<p>④ ECO button</p> <p>Press the 'ECO' button to set maximum water flow.</p> <p>In 'ECO' mode the water flow rate will be controlled by the flow control device to the following fixed rates: 6L/min, 7L/min, 8 L/min or 9L/min</p> <p>Press ECO button to exit 'ECO' mode, the appliance operates automatic water flow control. The water flow varies automatically depending on the delivery temperature selected and the ambient water temperature.</p>
	<p>⑤ Bath button</p> <p>This selection allows user to see the accumulated water consumed.</p> <p>Press 'Bath button' to set appliance to bath mode. The preset temperature and water flow can be set by pressing the 'UP' or 'Down' button and 'ECO' button.</p> <p>To exit the 'Bath mode', press the 'Bath button' again.</p>
	<p>Lock</p> <p>The Lock function is designed to prevent accidental operation and small children from altering the heater settings.</p> <p>Press and hold 'UP' and 'Down' button simultaneously until the padlock symbol is displayed. All control functions are now locked and none of the buttons on the control will work.</p> <p>To deactivate the lock, repeat locking step above to return the normal operation.</p>
	<p>TMax</p> <p>This Tmax display is for 50°C compliant models maximum delivery temperature adjustment from the 'Factory Set' value. See "50°C Compliant Models" on page 23 for more detailed information.</p>



During operation, when using any of the soft-touch buttons, the display reaches maximum brightness. When there is no operation after 10 seconds the display will dim, and the display will cease illuminating after 60 seconds. To wake the screen, press any button on the Control panel.



When the water heater re-starts from a power outage or is switched off, it will remain at the previous saved setting.

TURNING WATER HEATER 'OFF'

If the water heater is not going to be used for only a few days, we suggest you leave it switched on. For longer periods of inactivity, turn off both the water supply and power to the unit. This will ensure no risk of water freezing in the unit in very cold conditions. If it is necessary to switch off the water heater, the switch is usually marked and located in the electricity meter box of the building. Then close the cold water isolation valve at the inlet to the water heater. Opening the hot outlets may cause the heater to drain.

TURNING WATER HEATER 'ON'



DO NOT switch on the electric power supply until the water heater is filled completely with water. Always check that hot water is running freely from the hot water outlets before switching the heater on.

Switch on the electric supply to the water heater. The switch is usually marked and located in the electricity meter box of the building. Water heating will now occur as required.

CLEANING AND INSPECTION

It is recommended that you clean or inspect your appliance every six months or more regularly as required.

Switch off the electrical supply prior to carrying out cleaning and inspection. Use a non-abrasive damp cloth and mild detergent for cleaning appliance enclosure. **DO NOT** use alcohol, solvents or abrasive cleaning substances.

Inspect around the enclosure for insects, insect nests and spider webs which should be removed and cleaned out before powering and operating the unit. We recommend periodic pest control treatment to address this risk.



There are no consumer serviceable parts inside the appliance, access covers **MUST** only be removed by an authorised person.

Visually inspect power and water connections for damage.

DRAINING



Draining **MUST** be carried out by a qualified person.

Water may be **HOT** during draining.

Drain the water heater as follows:

1. Isolate or turn 'OFF' the water heater at the electricity supply.
2. Close the cold water isolation valve at the inlet to the water heater.
3. Open a hot tap. When water stops flowing, close the hot tap.
4. Loosen Brass Tee fittings of the inlet and outlet connections. Collect water from the water heater by using a suitable container.

TROUBLE SHOOTING

ERROR CODES

Your Rinnai electric continuous flow water heater has a self diagnostic capability. If a fault occurs, an Error Code will flash on the display of touch screen on the console of the water heater. This assists with diagnosing the fault. Please quote the code displayed when requesting service and warranty support.

Code	Description	Remedy
E1	Sensor failure	Service Call.
E2	Outlet temperature exceeds 75°C	Service Call.
E3	Outlet temperature exceeds 85°C	Service Call.
EE	Communication error between PCB boards	Service Call.

SAVE A SERVICE CALL

Check the items below before requesting a service call. Service and parts charges may be incurred where it is found that there is no fault with the water heater and the issue is related to the plumbing installation or is due to the failure of water or electric supplies.

Description	Possible Remedy
No display on the water heater	<ul style="list-style-type: none"> • Check the water heater switched on at the power supply. The switch is usually marked and located in the electricity meter box of the building. • Check power available. • Check the water heater is turned on at the console. • Press any button on the control panel console or turn on a hot water tap.
No water from the hot tap	<ul style="list-style-type: none"> • Check the cold water supply to the water heater. Ensure cold water isolation valve is fully open. • Check filter for blockages by an authorised person. If not resolved, book a Service call.
Cold water from the hot tap	<ul style="list-style-type: none"> • Check that power is available. • Check that the water heater is switched on at the power supply. • Check the water heater is turned on. • Check the temperature setting on Control panel console. if not set properly, adjust temperature by pressing 'Up' or 'Down' buttons. • Close the hot tap, wait 10 seconds then open the hot tap again. • Check that the hot tap is open enough. • The water heater will not turn on if the flow rate is less than 2.5 l/min.
Water is too hot or not hot enough	<ul style="list-style-type: none"> • Check the temperature setting on the Control panel console. If not set correctly, adjust the temperature by pressing 'Up' or 'Down' buttons. • A 50°C water heater can have the delivery temperature adjusted by a plumber to account for temperature losses in the hot pipes or to limit the maximum delivery temperature. Service call. • You may not have the correct size water heater for your requirements. Service call.

Description	Possible Remedy
Not enough water flow	<ul style="list-style-type: none"> • Is more water being used than the water heater can heat adequately? • The water flow varies automatically depending on the delivery temperature selected and the ambient water temperature. If more water taps are open or the ambient temperature is colder, the water heater will reduce the water flow automatically to maintain water temperature. • Is the water pressure adequate to deliver the desired flow rate? The specifications table on page 26 indicates the minimum and maximum water supply pressures and the minimum operating water flow rate in L/min. • The water heater is fitted with a filter to prevent the system from blockages due to debris. Have a plumber inspect the filter.
Temperature fluctuates	<ul style="list-style-type: none"> • Too many taps are in use at the same time. This may cause either a reduction in flow rate per tap or temperature fluctuations from the taps. • Are there several hot taps open, or are appliances such as a dishwasher or washing machine in use at the same time? • Check the flow of hot water from each tap to see if one or more outlets are using more water than you think. • The supply of consistent hot water temperature is dependent on the size of the water heater, the geographic location and the season. Have a plumber install a flow control valve to each shower outlet, basin and sink to reduce water usage. • The specifications table on page 26 indicates the flow rate required, and the maximum flow rate capable, from each model water heater at various cold water inlet temperatures to provide hot water at 40°C to a 9L/min limited shower rose.

SERVICE

This Water Heater does not contain user serviceable parts and **MUST** only be serviced and repaired by an authorised person.

Rinnai has a Service and Spare Parts network with personnel who are fully trained and equipped to give the best service on your Rinnai appliance. If your appliance requires service, please call our National Help Line or the Hot Water Service Line (contact numbers for which are on the back cover of this manual).



When making a service enquiry, having both the model and serial numbers available, will help our staff quickly identify your appliance and better attend to your needs.

This information should have been copied to the "Installation Record" on page 25 by your installer. However if this is not the case, the information can also be found on the data plate located on the left hand side of the appliance.

For safe and efficient operation and prevention of premature deterioration, Rinnai advises and recommends that this appliance be serviced every 12 months by an authorised service technician.

INSTALLATION TABLE OF CONTENTS

Operation Table of Contents	3
Installation	15
Regulations	15
Water Supply	15
Water Quality	15
Appliance Location and Minimum Clearances	16
Mounting of Appliance	17
Service Connection Points	18
Installation Configuration	18
Plumbing Connections to the Water Heater	19
Plumbing Connections from the Bottom of the Appliance	20
Electrical Supply	21
Electrical Connection	21
Wiring	22
Appliance Wiring Diagram	22
Commissioning	23
To fill & turn 'ON' the Water Heater	23
To turn 'OFF' the Water Heater	23
Delivery Temperature	23
50°C Compliant Models	23
For all Other Models	24
Installation Record	25
Specifications	26
Table 1. Technical Specifications	26
Contacts	28



INSTALLATION, SERVICE AND REMOVAL MUST BE BY AN APPROPRIATELY LICENSED TRADESPERSON ONLY (THIS NEEDS AN ELECTRICIAN AND A PLUMBER).

This appliance must be permanently connected to fixed wiring.

If the electrical conduit to the water heater is damaged, it **MUST** be replaced by a qualified person in order to avoid a hazard.

Removal of the access covers of the water heater will expose 415V 3 phase electrical supply. Access covers **MUST ONLY** be removed by an authorised person.

The resistivity of the water supply must not be less than 800 Ω .cm.

This appliance **MUST** be earthed in accordance with the Wiring Rules.

This appliance is **NOT** suitable for use as a spa or swimming pool heater.

This appliance is **NOT** to be used for a portable water supply.

DO NOT operate this system before reading the manufacturer's instructions.

DO NOT modify the electrical wiring of this appliance. If the control power wiring is damaged or deteriorated then it must be replaced by an Authorised Person. Failure to do so may result in electric shock, fire, serious injury or product failure.

REGULATIONS

This appliance **MUST** be installed in accordance with:

- Manufacturer's installation instructions
- Current AS/NZS 3000 Wiring Rules
- Plumbing Code of Australia (PCA) or New Zealand Building Code
- All local regulations and municipal building codes including local OH&S requirements

WATER SUPPLY

The appliance is intended to be permanently connected to a reticulated public water supply.

The maximum water supply pressure for the water heater is 850kPa. An approved Pressure Limiting Valve (PLV) may be required.

The minimum water supply pressure for the water heater is 100kPa. The water heater will operate at lower pressures but will not achieve the rated flow.

Minimum flow rate to initiate heating is 2.5L/min.

Water Quality

Water chemistry and impurity limits are detailed as below. Most metropolitan water supplies fall within the requirements. Water quality from bore wells is generally unsuitable. If you are unsure about your local water quality, contact your water authority. If sludge or foreign matter is present in the water supply, a suitable filter or strainer is required in the water supply to the water heater to prevent unwarranted damage and loss of performance.

Scaling water is defined as having a total hardness in excess of 200 mg/litre (expressed as calcium carbonate) or a Saturation Index in excess of +0.4. Areas that have a scaling water supply include South Australia and Western Australia. In a scaling water supply, calcium carbonate and possibly other compounds are deposited out of the water onto any hot metallic surfaces and form a scale.

Check with your local regulatory authorities as they may require an Expansion Control Valve (ECV) to be fitted. If required, in areas of poor quality or scaling water supply, an ECV should be fitted in the cold water line between the non return valve and the connection to the water heater to protect the water heater. The ECV is to be supplied and fitted by the installer.



Where the site water chemistry may not meet these limits, site sample water laboratory testing is required to demonstrate suitability. Where the actual chemistry or impurities are outside these specified limits, suitable water treatment **MUST** be implemented and maintained to protect the water heater and not void its warranties.

Electric Continuous Flow Heater Water chemistry and impurity level limits

Chlorides – mg/L	pH	Saturation Index	Total Dissolved Solids Range - mg/L	Water Resistivity Range - Ω.cm @ 20°C	Water Conductivity Range - μS/cm @ 20°C
≤ 200	5.5 to 9.5	-1.0 to +0.4 @65°C	≤875	≥800	≤1250

Water hardness and pH

In a high chloride water supply, calcium carbonate and possibly other compounds deposited out of the water, may corrode the heating element and other components and cause them to fail.



Rinnai warranty **DOES NOT** apply to the water heater where the water supply chloride level exceeds 200 mg/L.

pH is a measure of whether the water is alkaline or acid. In an acidic or very alkaline water supply, the water can attack the heating element and other components and other parts and cause them to fail.



Rinnai warranty **DOES NOT** apply to the water heater where the water supply pH is less than 5.5 or greater than 9.5.

Saturation Index

The saturation index is used as a measure of the water’s corrosive or scaling properties. In a corrosive water supply, the water can attack copper parts and cause them to fail.



Rinnai warranty **DOES NOT** apply to the water heater where water supply saturation index exceeds +0.40 or less than -1.0 @65°C.

Total Dissolved Solids (TDS), Resistivity and Conductivity

The resistivity of the water must be greater than 800 Ω.cm for the water heater to operate correctly. Resistivity lower than this may cause residual current devices (RCD) to trip.



Rinnai warranty **DOES NOT** apply to the water heater where water supply TDS more than 875mg/L, or Water Resistivity Ω.cm less than 800 Ω.cm, or Water Conductivity more than 1250 μS/cm.

APPLIANCE LOCATION AND MINIMUM CLEARANCES

This appliance is designed for ‘Indoor’ installation only.

The water heater should be placed as close as practicable to the most frequently used outlet point or points. This will usually be the kitchen tap.



- Ensure the appliance is **NOT** installed in locations where freezing can occur.
- Ensure the appliance is located away from heat or steam.
- Ensure the appliance is located so it can be accessed for service and replacement.
- Select a location where the appliance can be securely mounted.
- The minimum clearance shown below **MUST** be maintained.

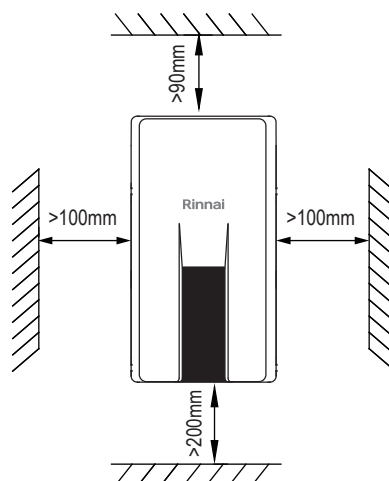

The wall or structure on which the units are to be mounted **MUST** be capable of supporting these weights and the associated pipe-work when filled. Refer to "Specifications" on page 26 for specific model weights.

MOUNTING OF APPLIANCE

- Remove the front cover.

<p>Remove the screw located underneath the appliance.</p>	<p>Carefully disconnect the display board cable and remove the front cover. NOTE: Factory default, the cable is disconnected.</p>	<p>Remove two screws and unclip the grey cover at the bottom of the heater.</p>

- Prepare the power cable from the walls.
- Determine electrical connection and plumbing connection method and location.(Refer to "Plumbing Connections to the Water Heater" on page 19 and "Electrical Connection" on page 21).

<p>Use the supplied installation mounting template to mark the 3 mounting hole positions (below), and location of plumbings and electrical connections.</p>	<p>Fix the water heater onto the wall using appropriate fixing screws suitable for the mounted surface material and able to support this unit.</p>

INSTALLATION

SERVICE CONNECTION POINTS

Refer to "Specifications" on page 26 for model specific connection / fitting dimension details.

An Approved full flow isolation valve and disconnection union **MUST** be fitted to the cold water. A non return valve is not required on the water inlet unless required by local regulations.

Isolation Valves **MUST NOT** be fitted directly to the appliance.

If may be necessary to fit a temperature limiting device for delivery to areas used primarily for the purposes of personal hygiene.

Clear all pipe work before connection and purge cold water supply lines to remove air and swarf before final connection of the appliance. Swarf in the water supplies may cause damage.



If olive compression fittings are used for connections the olives **MUST** be metallic such as brass or copper. Only approved thread sealing tape or sealant should be used.

Sealant **MUST NOT** be allowed in the waterways of pipework or fittings. Excess sealant may be carried into the water heater. It will damage components and block the internal filter.



Water pipe sizing and layout **MUST** be performed in accordance with AS/NZS 3500. All hot water pipe-work **MUST** be insulated to optimise performance and energy efficiency.

This appliance is intended to be permanently connected to the water mains and not connected by a hose-set.

Ensure all pipe connections be correctly aligned.

INSTALLATION CONFIGURATION



This appliance may deliver water at high temperature. Refer to the Plumbing Code of Australia (PCA), local requirements and installation instructions to determine if additional delivery temperature control is required.

If the appliance is marked to state that it delivers water not exceeding 50°C, local regulations may permit installation without a Temperature Limiting Device. Installations without a Temperature Limiting Device are shown in Diagram 1 below. If you are unsure about your local regulations contact your regulatory authority. If the appliance is **NOT** marked to state that it delivers water not exceeding 50°C, or your local regulations require installation with a Temperature Limiting Device then install the appliance in accordance with Diagram 2 below.



If the appliance is to deliver water primarily for the purposes of personal hygiene in an early childhood centre, primary or secondary school, nursing home or a similar facility for the care of young, aged, sick or disabled persons as defined in AS/NZ 3500 a Temperature Limiting Device (TLD), such as a Tempering Valve may be required even if the appliance is set to 50° C or less.

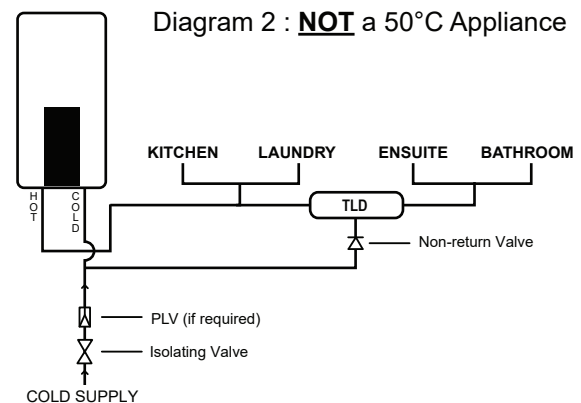
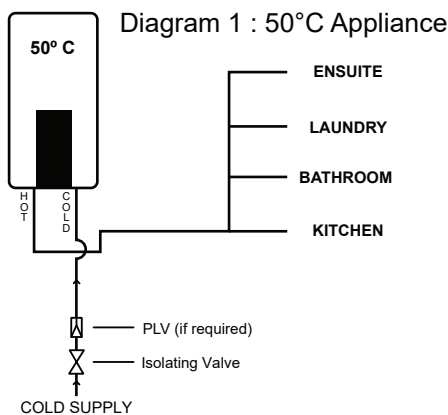

Minimum length of pipe from hot outlet to nearest hot water tap 1 metre.



TLD = Temperature Limiting Device.

PLUMBING CONNECTIONS TO THE WATER HEATER

Connections through the walls or back of the appliance

- The appliance is supplied with Brass Tee fittings.
- Fit a rubber washer in the cold and hot Brass Tee fittings.
- Connect to the cold and hot water supplies as shown below.
- Do not over-tighten connections.



Ensure the cold inlet Brass Tee fitting fully opens the auxiliary shut off feature. An approved isolating valve is still required.

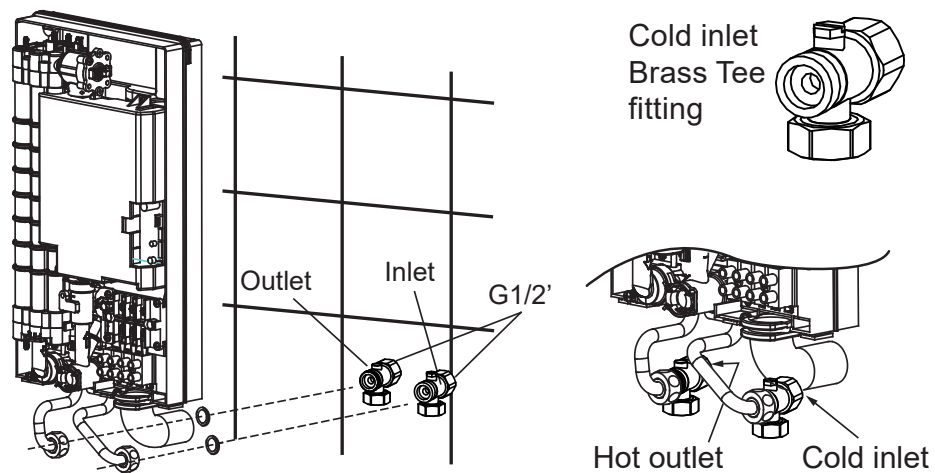

Dimensional Drawing

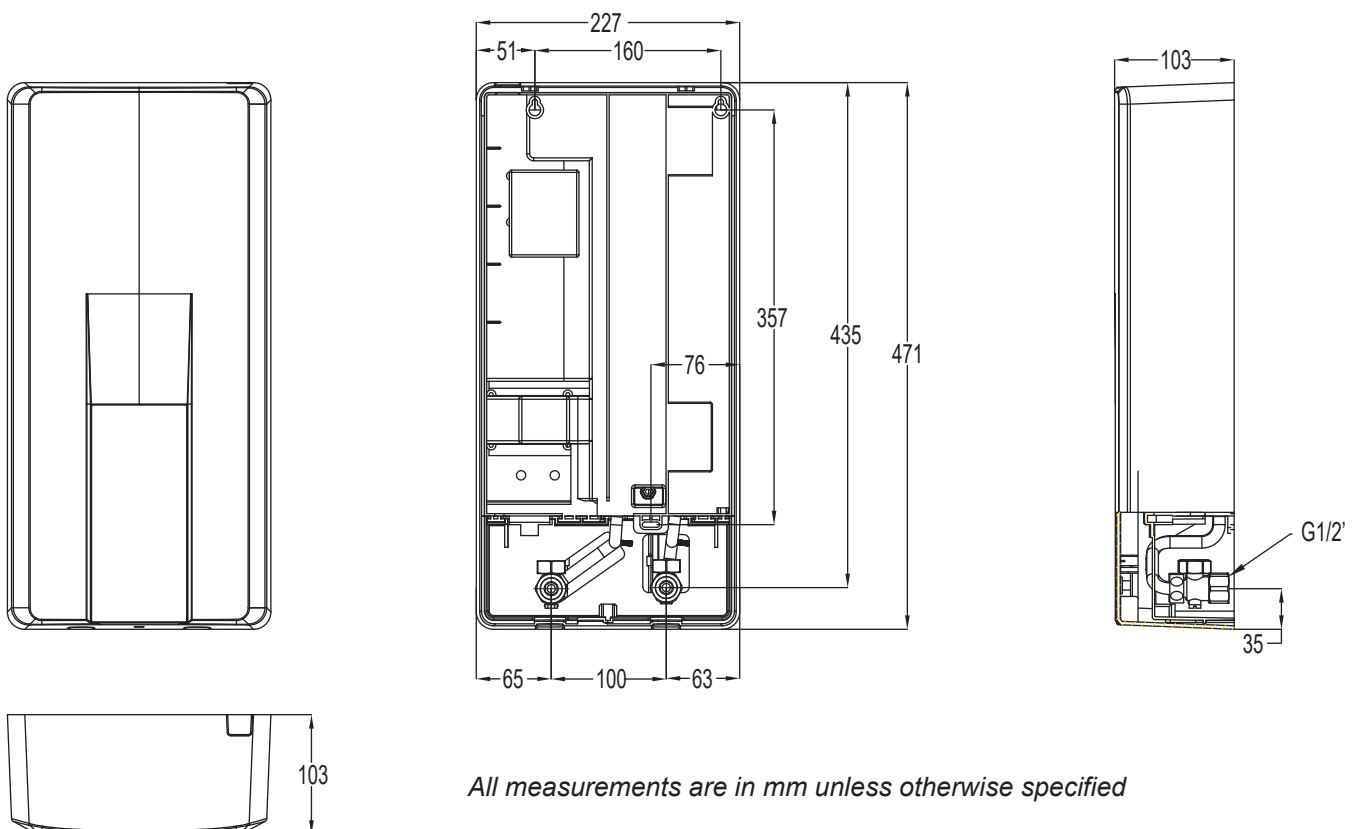

All measurements are in mm unless otherwise specified

PLUMBING CONNECTIONS FROM THE BOTTOM OF THE APPLIANCE

- For this installation, it will be required to remove the pipe knock-out from the bottom of the cover.
- Using suitable tools, gently cut or break out the knock-out.
- Clean up any burrs if required.

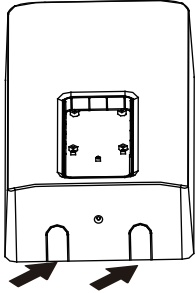

- Fit and tighten the cap onto the unused outlet as shown below. Make sure the rubber washers have been fitted.
- Let the opening facing down.

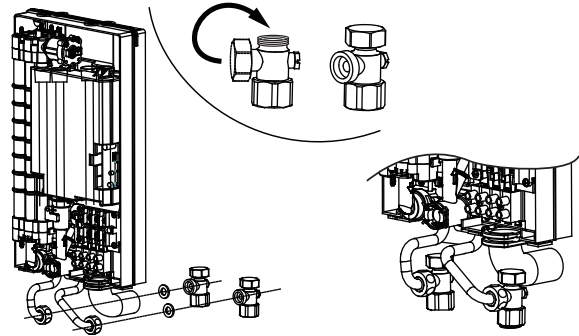

- Use the straight adapters provided for inlet and outlets as shown.
- Connect to the cold and hot water supplies to the R 1/2" male straight adapters with rubber washers.
- Do not over-tighten connections.

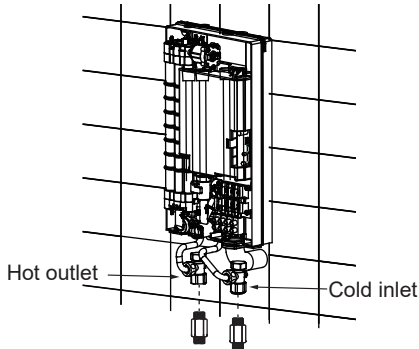

- Re-position the rubber conduit in the slot.
- Re-position the grey cover and fit it with 2 screws.
- Re-connect the communication cable to the main PCB.
- Cover and secure with screw.

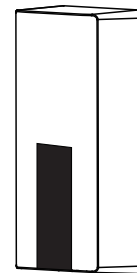

Dimensional Drawing

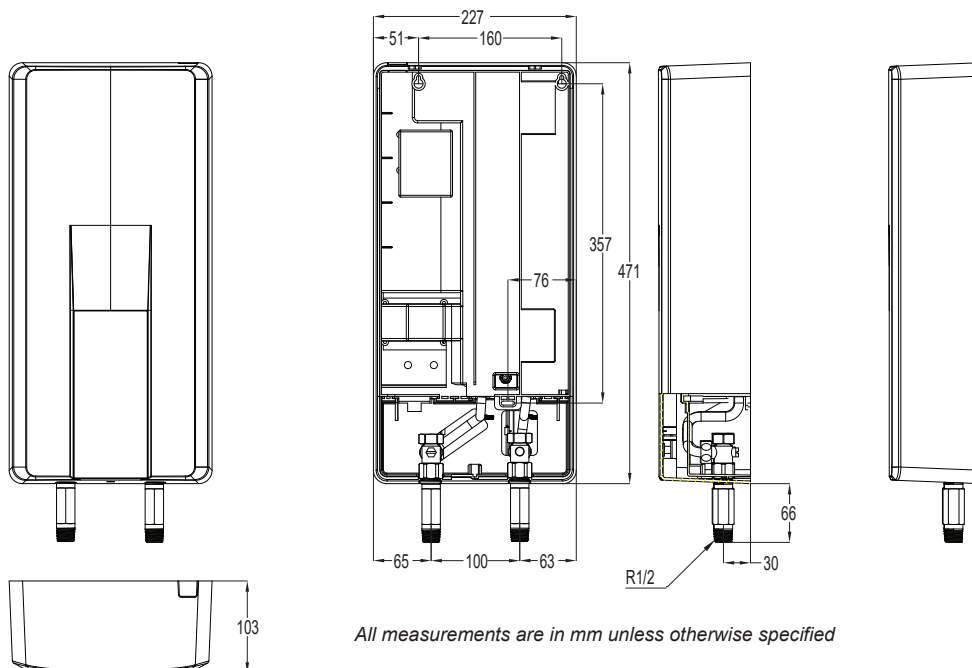

All measurements are in mm unless otherwise specified

ELECTRICAL SUPPLY



**HAZARDOUS VOLTAGE.
Risk of Electrical Shock.**



Isolate all sources of supply prior to servicing



This appliance **MUST** be installed, maintained and removed by **Authorised Persons** in accordance with AS/NZS 3000 (Wiring Rules) and all other relevant local regulations and municipal building codes including OH&S requirements.

Ensure the circuit is to be RCD protected.

Ensure electric wiring is installed properly. Improper installation may cause malfunction, fire, or electric shock.

The appliance **MUST** be earthed in accordance with local electrical requirements.

This appliance **MUST** connect to an independent, fused, AC 380-415V~ 3 phase 50HZ power supply with an isolating switch installed at the switch board. It **MUST** effectively isolate all active supply conductors from the circuit, and means for disconnection **MUST** be incorporated in the fixed wiring in accordance with the Wiring Rules.



The water heater **MUST** be filled with water prior to connection to the power supply.

Ensure the premises wiring to the system is capable of withstanding the system electrical load.

Electrical Specifications

Model	ECF19150			ECF19160			ECF29150			ECF29160		
Rated Voltage (VAC)	380	400	415	380	400	415	380	400	415	380	400	415
Rated Power Rate (kW)	16.2	18	19.4	16.2	18	19.4	24.4	27	28.5	24.4	27	28.5
Rated Current (A)	24.5	26	26.9	24.5	26	26.9	37	39.1	39.6	37	39.1	39.6
Phases/Frequency	3 phase 50Hz											
Water Resistivity (Ω .cm)	≥ 800											
Conductivity (μ S/cm)	≤ 1250											

ELECTRICAL CONNECTION

1. Prepare the power cable.
2. Open the appliance. Refer to more detailed instructions on page 17
3. Inset 3 phase power cable through rubber conduit.
4. Connect power cable to the main terminal at earth, L1, L2 and L3 as shown.
5. Ensure the rubber conduit is in the slot.
6. Re-position the grey cover and fit it with 2 screws.
7. Re-connect the communication cable to Main PCB.
8. Cover and secure with screw.

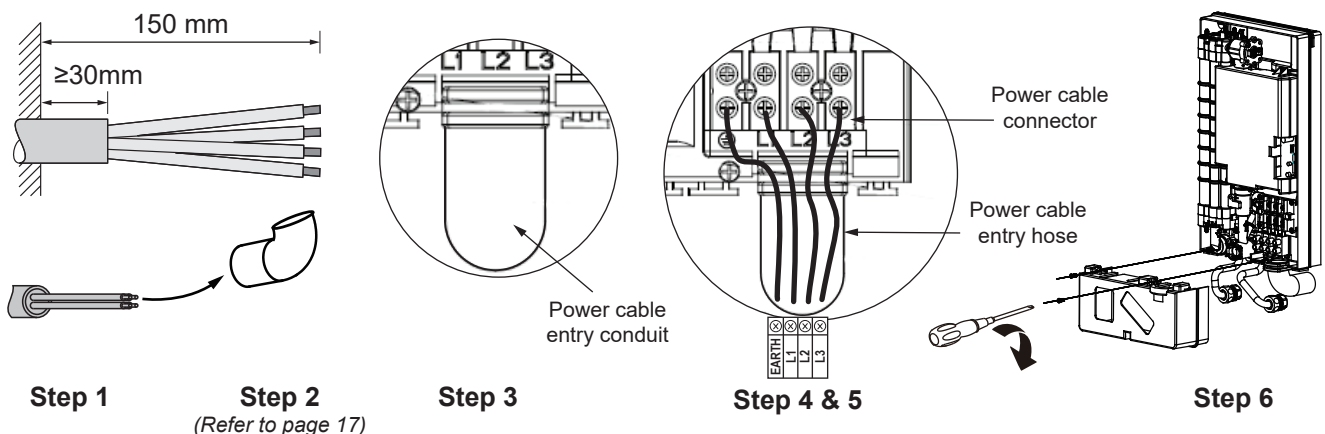

WIRING

APPLIANCE WIRING DIAGRAM

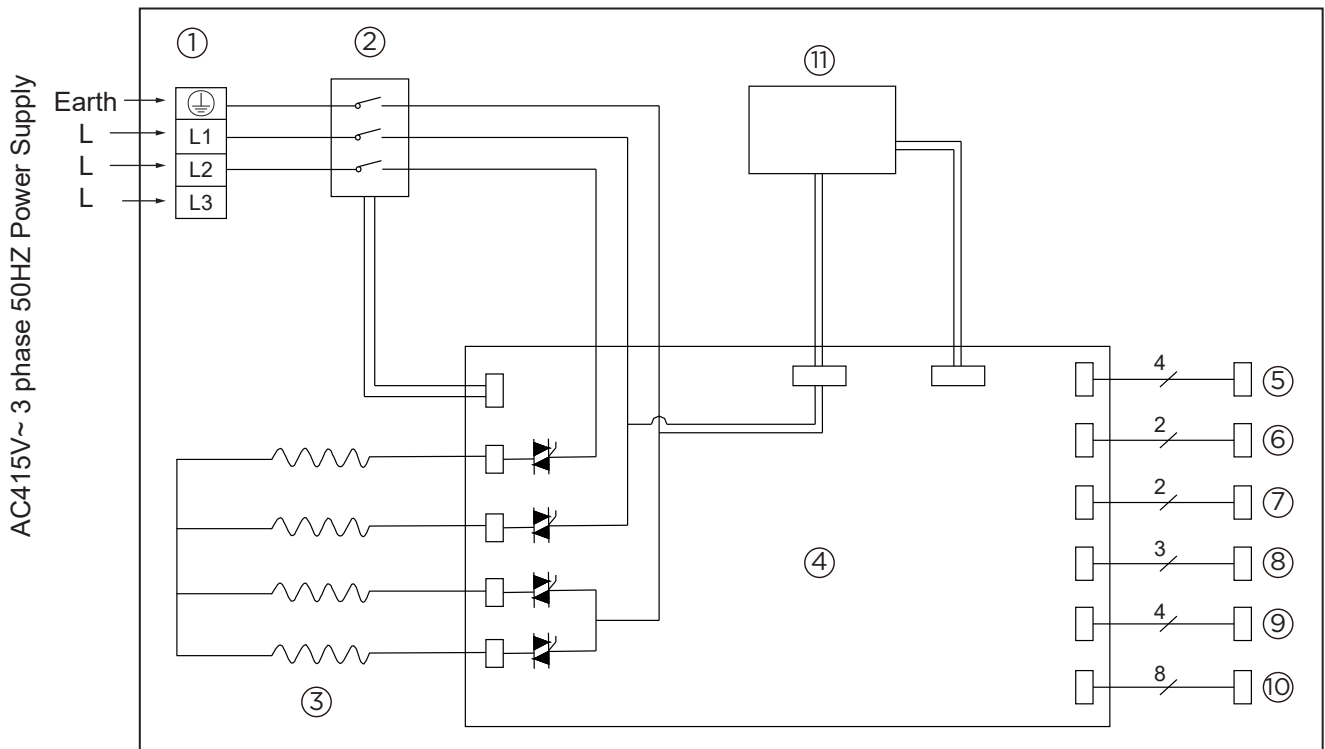

- ① Terminal Block
- ② Safety Contactor
- ③ Heating Element
- ④ Main PCB
- ⑤ Control Board
- ⑥ Over-Pressure Switch
- ⑦ Thermal Cut-Out
- ⑧ Water Flow Sensor
- ⑨ Cold Water Inlet Temp Sensor /
Hot Water Outlet Temp Sensor
- ⑩ Water Flow Control Device
- ⑪ Transformer



Commissioning **MUST** be carried out by an authorised person.

DO NOT switch on the electric power supply until the water heater is filled completely with water.

TO FILL & TURN 'ON' THE WATER HEATER

Before final connection of the water heater purge all hot water and cold water supply lines. Debris or swarf in water supplies may cause damage.

1. Open all hot water taps in the building, including the shower.
2. Open the cold water isolation valve to water heater. Air will now be forced out of the taps.
3. Close each tap when water runs freely without air bubbles.
4. Check all plumbing connections and pipe work for water leaks.
5. Turn on the water heater at the electric power supply.
6. Open hot water tap(s), and water heater will operate automatically
7. Confirm the hot water delivery temperature(s) using a thermometer. Refer to the section 'Delivery Temperature' below for more details.
8. If required, adjust temperature as per operation instruction.



The appliance can adjust water flow automatically to achieve preset temperature, you may notice the water heater reduce water flow rate. If required, adjust the preset outlet temperature setting of the water heater.

TO TURN 'OFF' THE WATER HEATER

It may be necessary to turn off a water heater after installation and commissioning, for example during building activities or if the premises are vacant.

1. Turn 'OFF' the water heater using the Control Panel Console and switch off the power at the electricity supply.
2. Close the cold water isolation valve at the inlet to the water heater.

Finally, explain to the householder the functions and operation of the water heater. Ensure the "Installation Record" on page 25 is completed and that this manual is returned to the customer.

DELIVERY TEMPERATURE



'50°C compliant' appliances have labelling applied to the left hand side panel (as shown), if this label is not evident, then the appliance is NOT '50°C compliant'. '50°C compliant' labelling on to the front cover alone does NOT make the appliance '50°C compliant'.

50°C Compliant Models

"50°C Compliant" appliances are factory set to deliver a maximum water temperature not exceeding 50°C. For fine tuning they have an incremental adjustment mechanism that allows the installer to increase the appliance delivery temperature incrementally from the 'Factory Set' value to temperatures slightly exceeding 50°C. This is intended to enable compensation for temperature losses in the pipe-work between the water heater and any outlets and achieve the required temperature at the outlet.

1. Carry out installation of the appliance in accordance with the Operation/Installation manual supplied with the appliance.
2. Measure the maximum hot water temperature from the sanitary fixture used primarily for the purposes of personal hygiene that is closest to the water heater (for example, a shower outlet in the bathroom closest to the water heater) as follows:
 - (i) Set the maximum temperature (this should be 50°C).
 - (ii) Open the hot tap to the outlet to achieve maximum flow rate (ensure the cold tap to this outlet remains shut).



Lead Free

This Appliance complies with current AS 3498 LIC. WM-032245

THIS APPLIANCE DELIVERS WATER NOT EXCEEDING 50°C IN ACCORDANCE WITH AS3498. REFER TO AS/NZS 3500.4 LOCAL REQUIREMENTS AND INSTALLATION INSTRUCTIONS TO DETERMINE IF ADDITIONAL DELIVERY TEMPERATURE CONTROL IS REQUIRED.

Minimum length of pipe from outlet of water heater to nearest hot water tap must be 1 metre.

WARNING

For continued safety of this appliance it **MUST** be installed, operated and maintained in accordance with the manufacturers' instructions.



- DO NOT** OPERATE THIS APPLIANCE BEFORE READING THE INSTRUCTION BOOKLET.
- DO NOT** PLACE ARTICLES ON OR AGAINST THIS APPLIANCE.
- DO NOT** STORE CHEMICALS OR FLAMMABLE MATERIALS, OR SPRAY AEROSOLS NEAR THIS APPLIANCE.
- DO NOT** OPERATE WITH PANELS, COVERS OR GUARDS REMOVED FROM THIS APPLIANCE.

SUITABLE ONLY FOR INDOOR INSTALLATION
CUSTOMER SERVICE ON THIS APPLIANCE
AUSTRALIA 1300 555 545

- (iii) Let the water run for a short period to allow flow rate and temperature to stabilise.
 - (iv) Measure the stabilised hot water temperature.
3. If the temperature in step (2) is less than 50°C, perform delivery temperature adjustment to increase the delivery temperature in accordance with the "50°C Compliant Appliances Guidance Notes" below. If the temperature in step (2) equals 50°C no adjustment is necessary.

50°C Compliant Appliances Guidance Notes

- (a) The greater the temperature loss from pipework between the water heater and outlets, the lower the delivery temperature of water flowing through outlets.
 - (b) The temperature loss from pipework between the water heater and outlets is affected by pipe length, flow rate and seasonal variations in ambient air and water temperatures.
 - (c) Temperature loss is typically lower at shorter pipe lengths and higher flow rates. This is taken into consideration in the operating and measurement parameters specified in procedure Step 2 above.
 - (d) For a given installation, temperature loss is typically greatest in winter when ambient air and water temperatures are lowest. Conversely, temperature loss is typically lowest in summer when these ambient temperatures are highest. It follows that the delivery temperature of water flowing through outlets is typically higher in summer than it is in winter. The installer is to take into consideration the effects of these seasonal variations in ambient temperatures when carrying out temperature adjustments.
4. After carrying out delivery temperature adjustment re-confirm the maximum hot water temperature from ALL outlets primarily used for the purposes of personal hygiene (for example, all bathroom shower and basin taps). In accordance with Step 2 above.

Procedure

- Turn 'OFF' the water heater on the Control Panel Console and switch off the power at the electricity supply.
- Open the front cover by removing the screw from the bottom.
- Hold the front cover while the display board cable is connected.
- Adjust the Dipswitch as required (refer to Dipswitch settings below).
- Replace cover
- Turn on Appliance

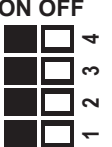
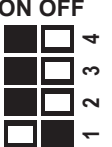
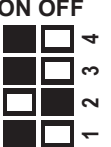
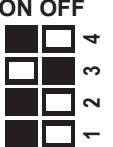
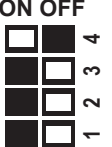
LOWEST TEMPERATURE INCREASE	FACTORY DEFAULT DELIVERY TEMPERATURE	TEMPERATURE INCREASE STEP 1	TEMPERATURE INCREASE STEP 2	TEMPERATURE INCREASE STEP 3	TEMPERATURE INCREASE STEP 4	HIGHEST TEMPERATURE INCREASE
	<p>ON OFF</p>  <p>SW1</p>	<p>ON OFF</p>  <p>SW1</p>	<p>ON OFF</p>  <p>SW1</p>	<p>ON OFF</p>  <p>SW1</p>	<p>ON OFF</p>  <p>SW1</p>	

Delivery Temperature Dipswitch Settings

For all Other Models

The water heaters are factory pre-set to various maximum delivery temperatures depending on model and their intended application. For the majority of applications, the factory pre-set temperature is appropriate. The customer can follow the Operation Instruction to select the desired temperature by touch screen.

A maximum delivery of 60°C is hot enough for most domestic applications and is suitable for use with thermostatic mixing valves and tempering valves. Local regulations and or the requirements of AS/NZS 3500.4 **MUST** be considered regarding the temperature limitations of hot water supplied to areas used primarily for personal hygiene. The temperature of the water to these areas may be limited to 50°C or less.

INSTALLATION RECORD

The Installation Record is a reference for the end user, help line staff and service technicians. Ensuring that this information is available here will be helpful in the event that a service enquiry is required.

Installer Details for Regulatory Compliance and Support

Installation Company Name: _____

Address: _____

Telephone / Mobile Phone: _____ / _____

Email: _____

Certificate of Compliance / Certification No.: _____

Authorised Persons - Licence No.: _____

Installers Name: _____

Installers Signature: _____

Installation Date: _____

System Details Required for Service Bookings and Support

Water Heater - Model Number *: _____

Water Heater - Serial Number *: _____

** This information will need to be copied from the data plate, located on the left hand side of appliance.*

Installation Address: _____

SPECIFICATIONS

TABLE 1. TECHNICAL SPECIFICATIONS

All dimensions referred to in these instructions are in millimetres, unless otherwise specified.

Model	ECF19I50			ECF19I60			ECF29I50			ECF29I60		
Electrical data												
Rated voltage (VAC)	380	400	415	380	400	415	380	400	415	380	400	415
Rated power rate (kW)	16.2	18	19.4	16.2	18	19.4	24.4	27	28.5	24.4	27	28.5
Rated current (A)	24.5	26	26.9	24.5	26	26.9	37	39.1	39.6	37	39.1	39.6
Phases/Frequency	3 phase 50Hz											
Water resistivity (Ω .cm)	≥ 800											
Conductivity (μ S/cm)	≤ 1250											
Plumbing connection / installation												
Installation	Indoor installation											
Dimensions (mm) H x W x D	483 x 228 x 95											
Weight (kg)	4.3											
Water connection	G 1/2' Female or R 1/2' Male											
Temperature range ($^{\circ}$ C)	30 - 50			30 - 60			30 - 50			30 - 60		
Water supply pressure	Min (kPa)		100									
	Max (kPa)		850									
Minimum operating flow rate (L/min)	2.5											
Ambient operating temperature range ($^{\circ}$ C)	5 - 45											
Flow rate @ 28k (L/min)	9.9 @ 415V						14.5 @ 415V					
Flow rate @ 50k (L/min)	5.5 @415V						8.0 @ 415V					
IP Rating	IP25											
Colour	Euro White											

Rinnai Australia Pty Ltd

ABN 74 005 138 769 | AU45204

100 Atlantic Drive, Keysborough, Victoria 3173
P.O. Box 460, Braeside, Victoria 3195
Tel: (03) 9271 6625

National Help Line

Tel: 1300 555 545*
Monday to Friday, 8.00 am to 5.00 pm EST.

After Hours Hot Water Service Line

Tel: 1800 000 340*

**Cost of a local call may be higher from a mobile phone.
(National calls from public phones in Australia are free.)*

For further information visit www.rinnai.com.au
or email enquiry@rinnai.com.au

Rinnai New Zealand Ltd

105 Pavilion Drive, Mangere, Auckland
PO Box 53177, Auckland Airport, Auckland 2150
Tel: (09) 257-3800
Toll Free: 0800 764-624

For further information visit:

www.rinnai.co.nz
youtube.com/rinnainz
facebook.com/rinnainz
or email info@rinnai.co.nz

Rinnai has a Service and Spare Parts network with personnel who are fully trained and equipped to give the best service on your Rinnai appliance. If your appliance requires service, please call our National Help Line. Rinnai recommends that this appliance be serviced every 12 months.

With our policy of continuous improvement, we reserve the right to change, or discontinue at any time, specifications or designs without notice.