

madimack

USER'S MANUAL

ECLIPSE

Inverter Pool Heat Pump



INDEX

00

a. foreword
1) cover the basics

02

b. Safety precautions
1) Warning
2) Attention
3) Safety

05

c. About your heat pump
1) Transportation
2) Accessories
3) Features
4) operation range
5) into of different modes
6) technical parameters
7) Dimension

10

d. Installation guidance
1) Installation reminder
2) Placing the unit and water connections
3) wiring requirements
4) Electric wiring diagram
5) References for protecting device and cable specification
6) Installation options
7) Control socket connection

24

e. operation guidance
1) Display functions
2) Operation instructions

28

f. testing
1) heat pump checks before use
2) refrigerant leak detection
3) Trial
4) Running status check

33

g. commissioning

35

h. Maintenance

37

i. troubleshooting for common faults

41

j. Wi-Fi operation

50

l. Product purchase
Warranty Registration

a. FOREWORD

Thank you for choosing the **Madimack** high efficiency inverter pool heat pump!

All our heat pumps are built and designed to the highest standard and are protected by our extended warranty service for peace of mind.

Warranty registration is required to be submitted online in conjunction with the commissioning page and warranty registration page in the Appendix section at the back of the booklet www.madimack.com.au/warranty-registration.

Please read and fully understand all information provided before attempting to install the pool heat pump.

For technical questions and further information please contact support@madimack.com.au.

We hope you enjoy using our heat pumps.

Thank you!

COVER THE BASICS:

1. Check that you have received the package in good condition
2. Every residential heat pump comes with two accessory boxes and the manual. The manual will mention all the parts and where they belong to make sure that the unit is commissioned, as per the 'commissioning' section, and that adequate water flow rate is provided
3. Keep the surroundings of the unit clear of any debris, tree branches, and anything that can affect the ventilation of the unit
4. Keep the invoice/packing slip in a safe place.
5. Register the unit for warranty as per the warranty section in this manual
6. Ensure that the unit is installed in an outdoor area, if it has to be indoors the unit will need to be ducted to the outside
7. The condensate drain will need regular check-ups for any blockages or debris build ups, Keeping it clean allows the condensate drain to escape easily to drainage
8. For Wi-Fi control make sure that you have full Wi-Fi strength in the heat pump area, more than -50 DB is recommended for strong connection
9. Make sure that the unit is installed as per the ventilation diagrams to ensure efficient heating rates

b.

Safety Precautions

We have provided important safety messages in this manual for the installation, maintenance and repair of your heater.

Please read thoroughly and obey all safety messages.

Environmentally friendly R32 Refrigerant is used in this heat pump.

1.Warning



This WARNING sign denotes a hazard. It calls attention to a procedure, practice, or the like, which, if not correctly performed or adhered to, could result in personal injury or injury to a third party. These signs are rare, but are extremely important.

	a. Keep the heat pump away from fire source.
	b. Unit must be placed in a well-ventilated area; indoor or enclosed areas are not allowed.
	c. Repair and disposal must be carried out by trained service personnel
	d. Vacuum the system completely before welding. Welding should only be carried out by professional trained personnel.

2.Attention

- a. Please read the following instructions before installation, use and maintenance.
- b. Installation must be completed only by competent persons only, and in accordance with this manual.
- c. Check all water connections are sealed and tested before operating the machine
- d. Except for the methods recommended by the manufacturer, do not use any methods to accelerate the defrosting process or clean the frosted parts.
- e. If a repair is required, please contact the nearest after-sales service center. The repair process must be strictly in accordance with this manual. Repairs made by unauthorized persons may void the warranty.
- f. Correctly set temperature required for personal preference making sure to avoid overheating or overcooling.
- g. Please do use or stack substances or other materials which may block the air flows to the inlet or outlet areas. This causes the efficiency of the heater to be reduced, and may damage the machine.
- h. Do not use or stock combustible gas or liquids such as thinners, paint and fuel, to avoid fire!
- i. In order to optimize the heating effect, please install heat preservation insulation on pipes between swimming pool and the heater, and please use a recommended cover on the swimming pool.
- j. Connecting pipes of the swimming pool and the heater should be less than 10m.

3.Safety

- a. Please keep the main power supply switch out of reach from the children.
- b. If power is suddenly disconnected during operation, and later the power is restored, the heater will start up automatically.
- c. Please switch off the main power supply in high storm weather to prevent the machine from damage that could be caused by lightning strikes.
- d. Any repairs should be carried out in a well-ventilated area. Any source of ignition is prohibited during the inspection.
- e. Safety inspection must be carried before the maintenance or repair for heat pumps with R32 gas in order to minimize the risk.
- f. If R32 gas leaks during the installation process, all operations must be stopped immediately and call your local service center.

C.

About your heat pump

1. Transportation

a. Always keep upright

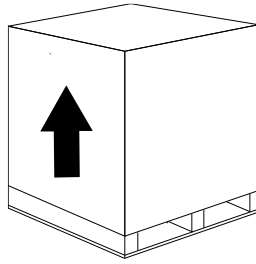

b. Do not lift the water union
(Otherwise, the titanium heat exchanger may be damaged)

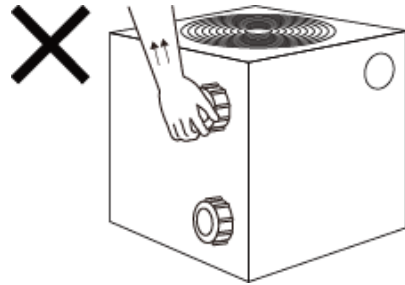

2. Accessories

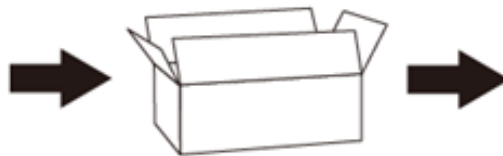
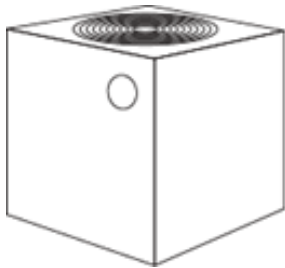

4 x Rubber Feet

Water Union



Drainage kit



Connection of the condensate drainage kit:

①

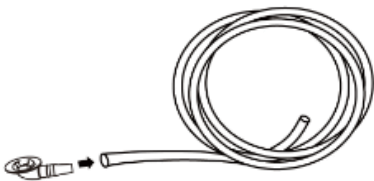

②

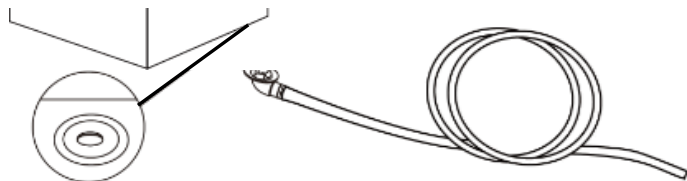

3.Features

- a. DC Twin-rotary inverter compressor
- b. DC Brushless fan motor
- c. EEV Technology
- d. High efficiency twisted titanium heat exchanger
- e. Sensitive and accurate temp control and water temp display
- f. High pressure and low-pressure protection
- g. Full protection on electrical system



4.Operating condition and range

To provide you comfort and pleasure, please set swimming pool water temperature efficiently and economically.

- a. Air temperature operating range: $-10^{\circ}\text{C} \sim 43^{\circ}\text{C}$
- b. The heat pump will have best performance in operating temperature range of ambient Air $15^{\circ}\text{C} \sim 25^{\circ}\text{C}$
- c. Cooling temperature $12^{\circ}\text{C} \sim 30^{\circ}\text{C}$
- d. Heating temperature $18^{\circ}\text{C} \sim 40^{\circ}\text{C}$

5.Introduction of different modes

- a. The heat pump has two modes: Boost and Silent.
- b. They have different strengths under different conditions.

Mode	Modes	Strength
	Boost mode	Heating capacity: 20% ~ 100% capacity Intelligent optimization Fast heating
	Silence mode	Heating capacity: 20% ~ 80% capacity Sound level: 3dB (A) lower than Boost mode High efficiency and energy saving

6. Technical parameter

Model	MM-ETD160	MM-ETD210	MM-ETD260
PERFORMANCE CONDITION: Air 27°C/ Water 27°C/ Humid. 80%			
Heating capacity (kW)	16.5	21.0	26.0
Heating capacity (kW) in Silence mode	14.3	18.7	23.8
COP range	15.6~7.2	15.9~7	15.8~6.9
Average COP at 50% speed	11.6	11.8	11.5
PERFORMANCE CONDITION: Air 15°C/ Water 26°C/ Humid. 70%			
Heating capacity (kW)	11.7	15.1	18.6
Heating capacity (kW) in Silence mode	10.1	13.2	17.2
COP range	7.2~5.1	7.8~5.0	7.5~4.8
Average COP at 50% speed	6.8	7.1	7.1
PERFORMANCE CONDITION: Air 15°C/ Water 26°C/ Humid. 70%			
Cooling capacity (kW)	7.3	9.0	11.2
TECHNICAL SPECIFICATIONS			
Operating air temperature (°C)	-10°C~43°C		
Power supply	230V 1Ph		
Compressor	Full stepless DC Compressor		
Casing	Marine Grade Aluminium alloy		
Rated input power (kW)	0.38~2.33	0.45~3.00	0.84~3.91
Rated input current (A)	1.66~10.1	1.96~13.00	3.65~17.00
Sound level at 10m dB(A)	21.2~34.9	32.8~34.7	31.5~35.2
Advised water flux (L/min) ±20%	100	125	150
Net dimension L x W x H (mm)	780 x 710 x 656	780 x 710 x 656	780 x 710 x 756
Water connection (mm)	40		

Remarks:

This heat pump is able to perform normal within air temp -10°C~+43°C, efficiency will not be guaranteed out of this range. Please take into consideration that the pool heat pump performance and parameters are different under various conditions.

Related parameters are subject to adjustment periodically for technical improvement without further notice. For the most up to date details, please refer to nameplate on the heat pump.

7.Dimension

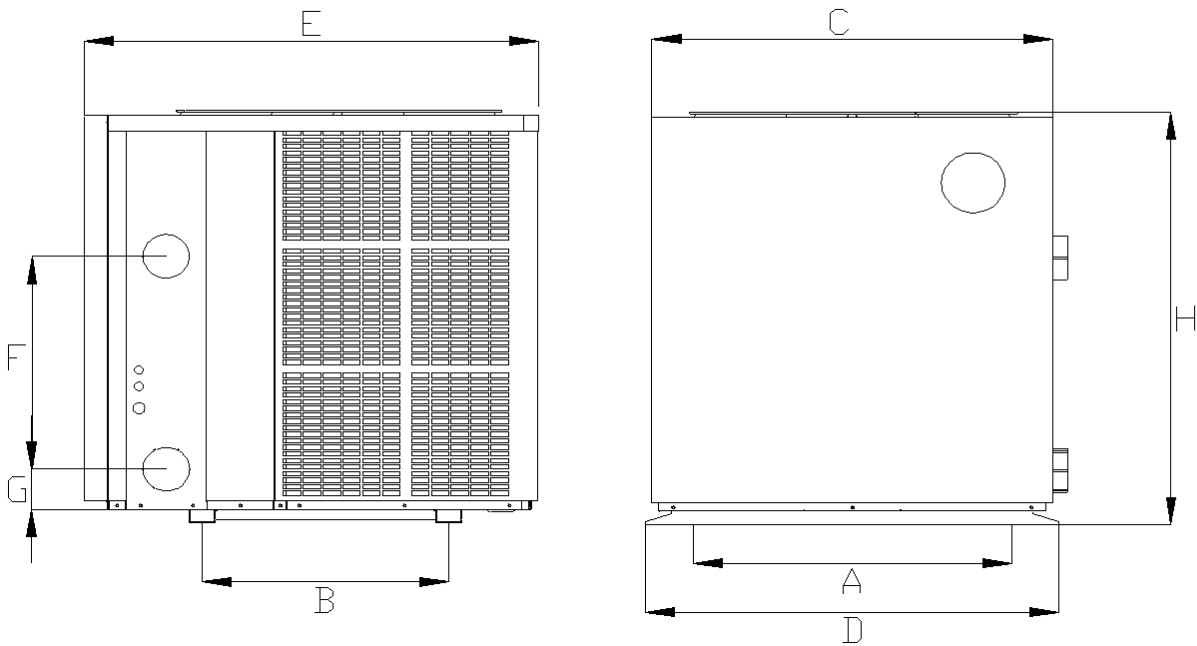

Size(mm) / Name / Model	A	B	C	D	E	F	G	H
ETD160/240MM	685	423	689	710	780	340	75	656
ETD210/240MM	685	423	689	710	780	390	75	656
ETD260/240MM	685	423	689	710	780	460	75	756

※ Above data is subject to modification without notice.

Note: The picture above and the specification diagram of the pool heater is for the technician's installation and layout reference only. The product is subject to adjustment periodically for improvement without notice.

d.

Installation Guidance

1st case: Single unit – 3 obstacles

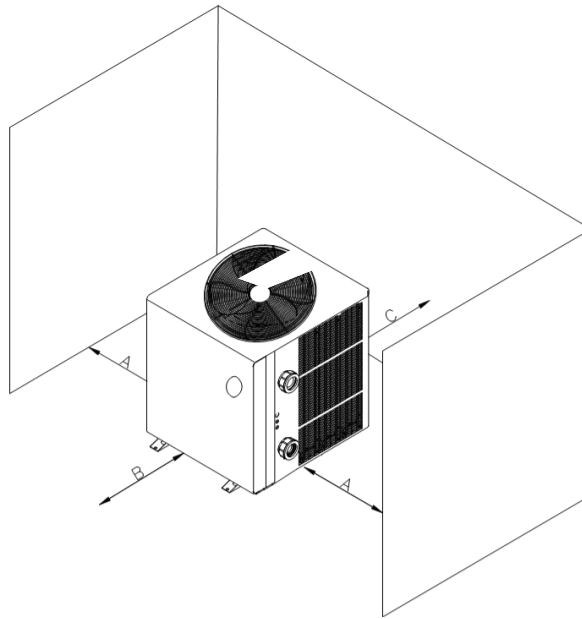

Model number	ETD160	ETD210	ETD260
Distance A (mm)	250	250	300
Distance B (mm)	250	250	300
Distance C (mm)	250	250	300

Please note that these are absolute minimum distances and where possible should always have a greater difference. Under no circumstances should any of the distances be reduced as performance will be affected. More ventilation is better.

The above diagrams assume that it's a completely clear above the unit

These units must be installed outdoors in a well-ventilated area, its recommended not to be installed in decks, under houses, in sheds, or any sorts of indoor locations.

2nd case: Multiple units – 3 obstacles

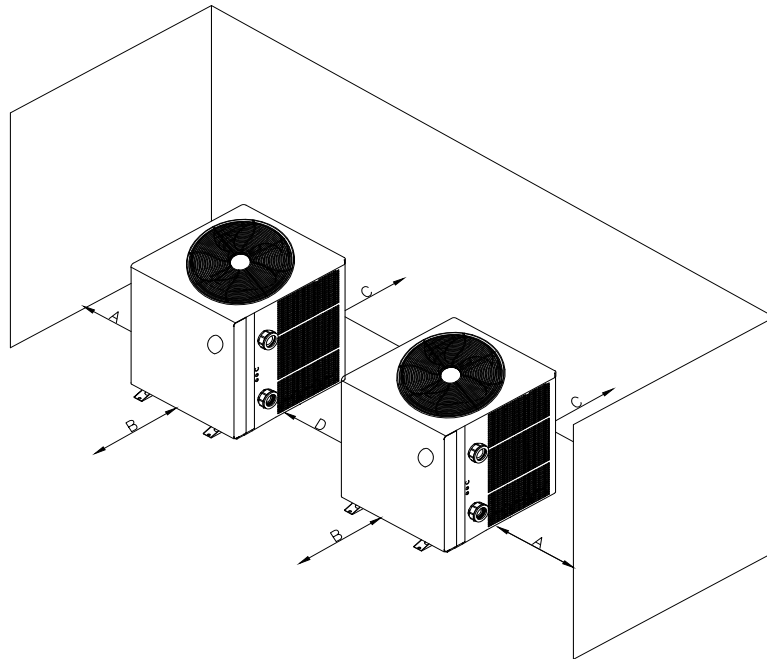

Model number	ETD160	ETD210	ETD260
Distance A (mm)	250	250	300
Distance B (mm)	250	250	300
Distance C (mm)	250	250	300
Distance D (mm)	500	500	600

Please note that these are absolute minimum distances and where possible should always have a greater difference. Under no circumstances should any of the distances be reduced as performance will be affected. More ventilation is better.

The above diagrams assume that it's a completely clear above the unit

These units must be installed outdoors in a well-ventilated area, its recommended not to be installed in decks, under houses, in sheds, or any sorts of indoor locations.

Plumbing Multiple units:

Multiple heat pumps acting as one system should be connected in Cascade (Parallel Connection). Adequate flowrate should be provided to all the units in the system to ensure efficient heating (Please refer to the commissioning section in the manual to learn about heat pumps commissioning). The diagram below represents the cascade connection

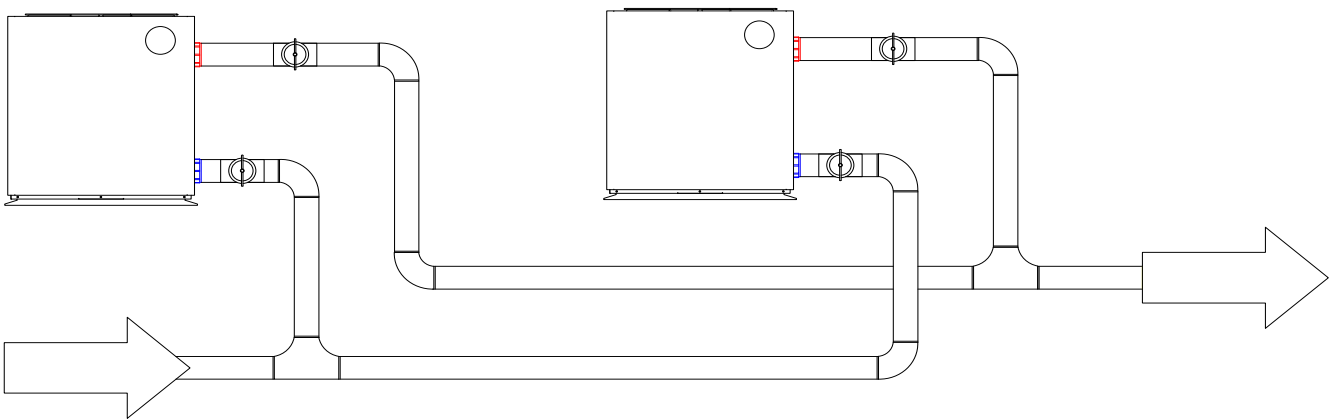

1. Installation reminder

Only competent persons are authorized to install the heat pump and should be educated with the relevant building codes and standards of their current state or local governing body for all electrical, mechanical and water services to prevent danger or damage to the unit.

a. Location and clearances

- Please consult with your local service centre for indoor installation requirements

 The inverter pool heat pump should be installed in a well-ventilated area.

b. Typical installation diagram

Installations can differ dependent on-site conditions below is only a representation of one possibility.

Note: the inlet and outlet positions for the pipework is a representation only and can be positioned differently.

Please see section: Installation options for more information of accessories available and different plumbing layouts

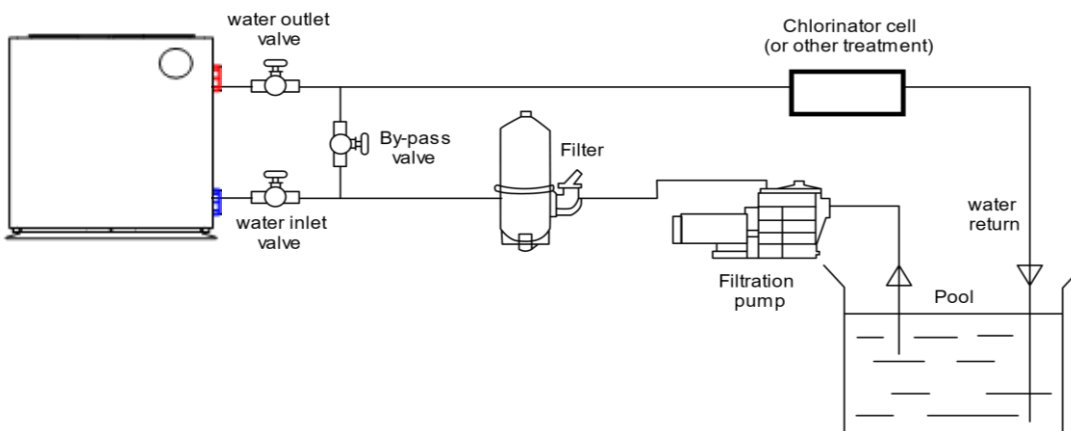

2. Placing the unit and water connections

a. Placing the unit and fixing

- The frame must be fixed by bolts (M10) to concrete foundation or brackets. The concrete foundation must be solid and fastened; the bracket must be strong enough and anti-rust treated.
- Do not stack substances that will block air flow near the inlet or outlet area, and there should be no obstruction within 50cm behind the machine. Suffocation of air reduces the efficiency of the heater and could damage the unit.
- The machine may need an additional pump (not supplied). The recommended pump must adhere to the specification-flux of the machine, please refer to the technical parameters.

b. Water connections and condensation

- The inlet and outlet water unions should not be installed with soft flexible pipes. The heat pump **must** be connected with rigid pipes!
- When the machine is running, condensation is created and discharged from the bottom. Please place the drainage nozzle (accessory) into the hole and clip it well, then connect a pipe to drain the condensation water away.

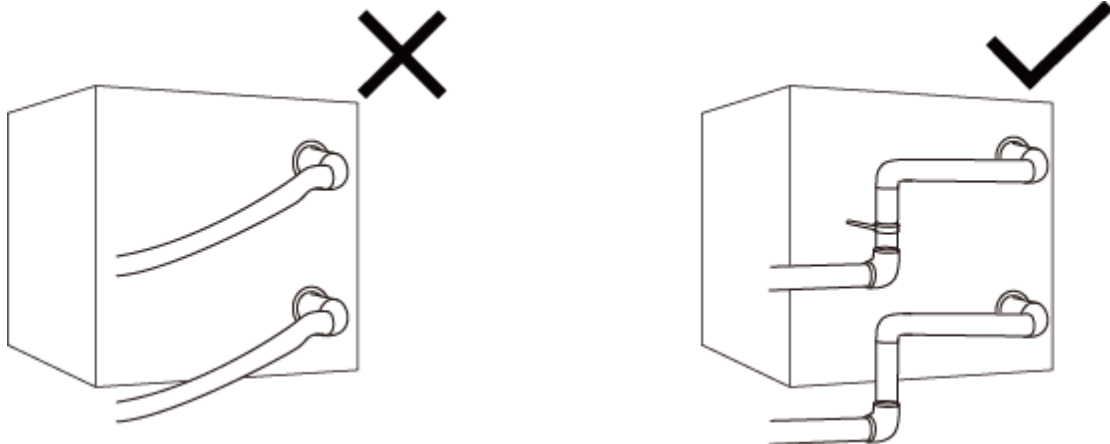

3. Wiring requirements

- a. Connect the heat pump to an appropriate power supply, the voltage should comply with the rated voltage of the product.
- b. The machine **must** be earthed
- c. Wiring must be handled by a professional technician according to the circuit diagram.
- d. Install electrical protection device according to local code for wiring
- e. The layout of power cable and signal cable should be orderly and not affecting each other.

4. Electric wiring diagram

a. For power supply: 230V 50Hz

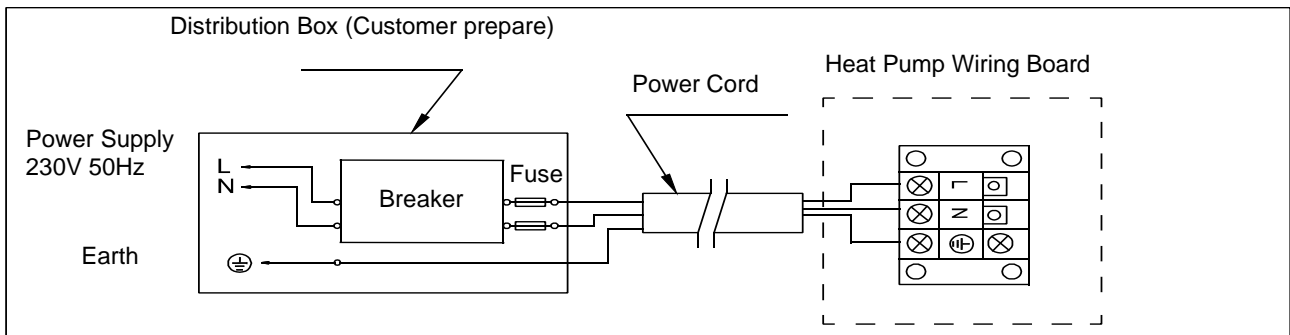

Attention: The pool heat pump must be earthed

5. References for protecting devices and cable specification

MODEL		ETD160	ETD210	ETD260
Breaker	Max Rated Current (A)	16	20	25
	Rated Residual Action Current (mA)	30	30	30

※ Above data is subject to modification without notice.

Note:The above data is associated to power cables less than 10m. If the power cable is longer than 10m, the wire diameter must be increased in accordance with current regulations. The signal cable can be extended to a maximum of 50m.

6. Installation options:

- **Flow switch activated heating**

The heat pump is activated by the flow of water initiated from the filtration/circulation pump, if the heater gets to temperature within the timers the unit will first start to use the inverter technology to slow the machine down to maintain the temperature and eventually to a stop.

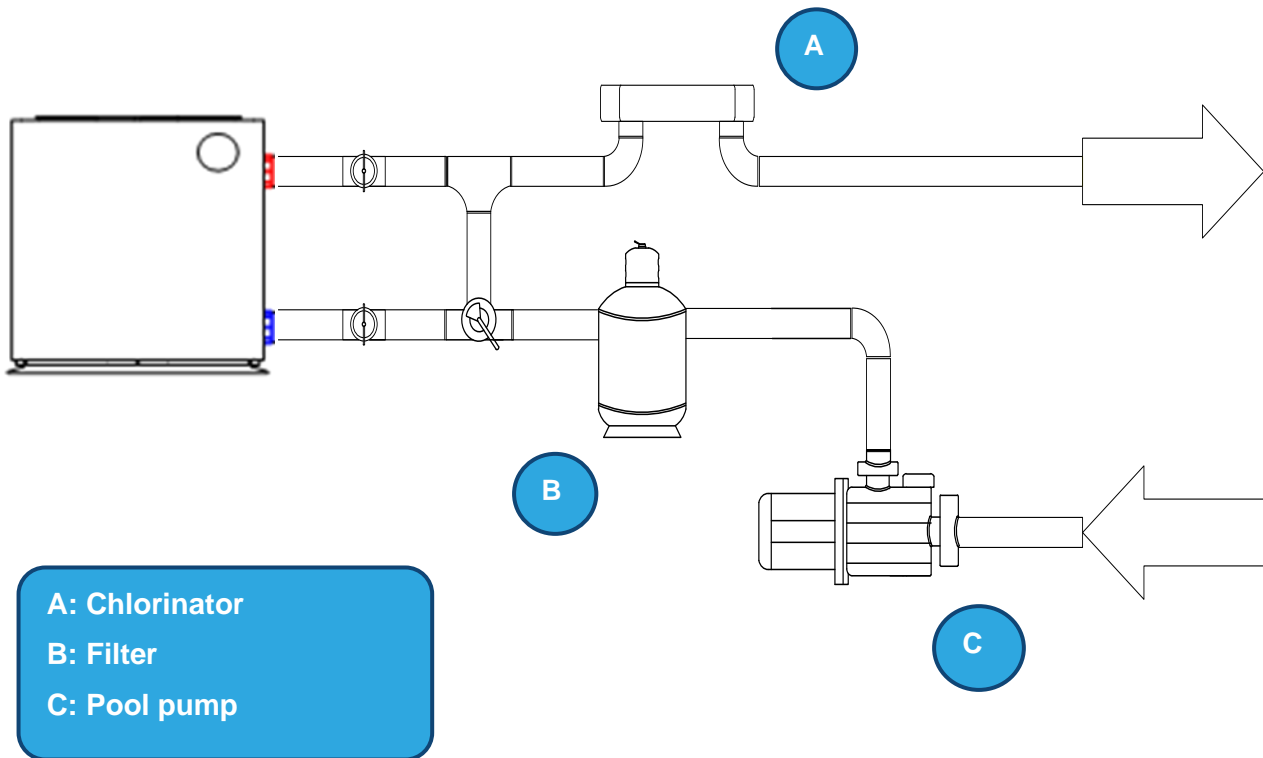

1. Chlorinator controller initiates the filtration pump.
2. Heat pump's flow switch senses the water flowing through the heat pump.
3. Heat pump starts and will run until temperature is reached or filtration pump switches off
4. No additional internal wiring to the heat pump is required in this set up
5. No additional settings needed to be changed
6. If circulation pump is not running and no flow is detected unit will display E3 – this is normal and an indication the unit is sitting idle waiting for the filtration pump to start again.
7. If the pool temperature is not reached within the filtration times you may need to extend the timers to match the heating requirement.

- **Heat pump activation without using the chlorinator controller and using the one pump used for filtration (additional controller required)**

An on-board pump output relay can activate the main filtration pump by using it in combination with a “single pump controller” without using the chlorinator timers needing to be activated which will stop over chlorination but still use a single supply pipework for the pool. This set-up is best when only single pipework is available from pool and doesn't have individual heating pipework. Efficient with only one pump working.

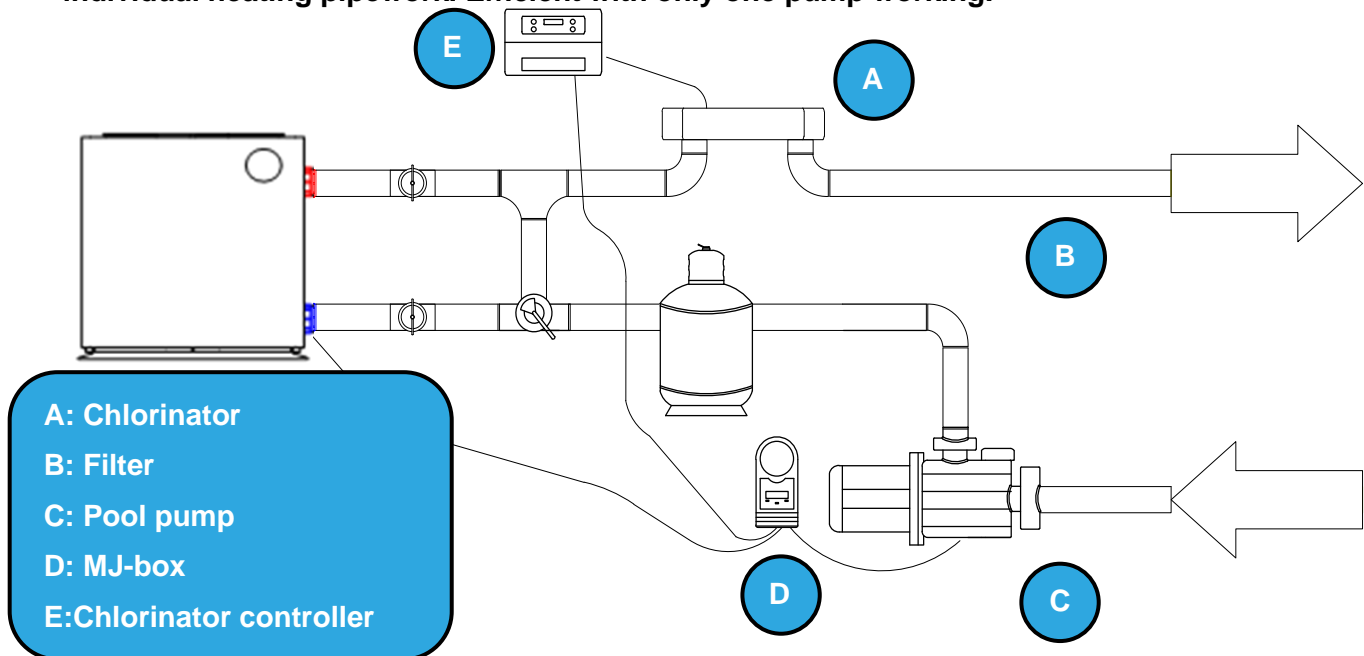

1. Termination socket is labelled (Pump control output) found on the side of heat pump, and connects to P1 – P2 on the on-board relay and is activated by the timers and pool temperature.
2. Once temperature is reached or the timer is finished the heat pump will switch off the relay output stopping the circulation pump.
3. If the pool reaches temperature but the timer is still active the heat pump will switch off relay to stop the circulation pump. Whilst the timer is still active every hour it will run the circulation pump for 2 minutes to test the water temperature. If the temperature is 1 degree below set point the heat pump will continue to run the circulation pump and start the heating process again.
4. Pump control socket only to be used with low voltage cable and devices
5. Heat Pump timers are set through the mobile application and required a Wi-Fi connection. If no Wi-Fi is present, then additional external timer may be required (sold separately)
6. On the single pump controller, connect the black power cable to a 240V GPO, connect the piggyback cord into the chlorinator, and plug the pump into the bottom of the controller.
7. Connect the Fig 8 wire from the single pump controller to the pump control output terminals. (See single pump controller manual for more information)
8. Adjust parameter “P6” to 100 as per section E

c. Individual circulation pump installation

An onboard output initiates the circulation pump to start and stop from the heat pump itself based on temperature and timers. For use when there are dedicated heating pipes and to separate from the filtration timer

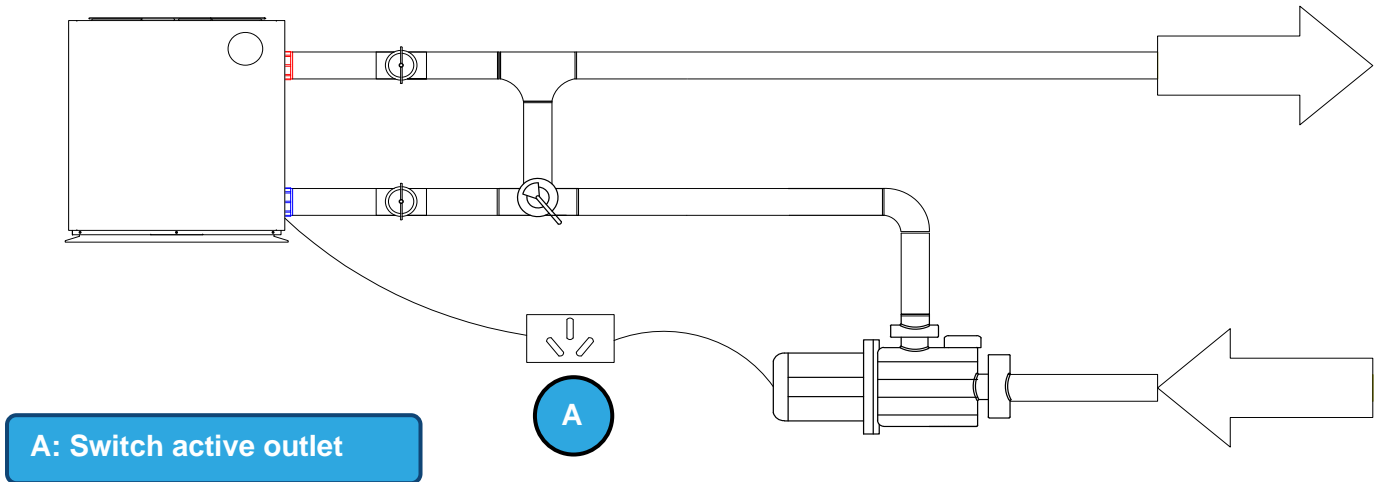

1. Must be completed by a qualified electrician
2. Termination points are labelled P1-P2 inside the electrical compartment Relay is activated by timers and pool temperature.
3. Once temperature is reached or the timer is finished the heat pump will switch off the relay output stopping the circulation pump.
4. If the pool reaches temperature but the timer is still active the heat pump will switch off relay to stop the circulation pump. Whilst the timer is still active every hour it will run the circulation pump for 2 minutes to test the water temperature. If the temperature is 1 degree below set point the heat pump will continue to run the circulation pump and start the heating process again.
5. Please remove any terminals within P1-P2 before connecting 230V.
6. P1 – P2 relay up to 10A output for circulation pump (check total load on circuit when combined) (P1 and P2 is an output relay switch not active neutral terminals, please see wiring diagram for further information.)
7. Heat Pump timers are set through the mobile application and required a Wi-Fi connection. If no Wi-Fi is present then additional external timer may be required (sold separately)
8. It is recommended to install a power point for the pump to plug into for any future service work to the pump which may be required.
9. Circulation pump should be sized accordingly to suit the site conditions and flow required.

Adjust parameter “P6” to 100 as per section E

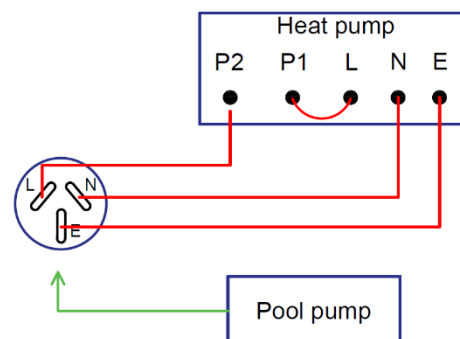

d. Solar retro

In some situations, when a heat pump is replacing a solar heating system, the pipework is available to be used next to the house but there is no way of adding a new electrical circuit to the pool equipment. With the use of an additional temperature sensor, you can use the in-built flow switch to activate the heating. Allowing you to use the existing solar pump and to install the heater closer to the switch board.

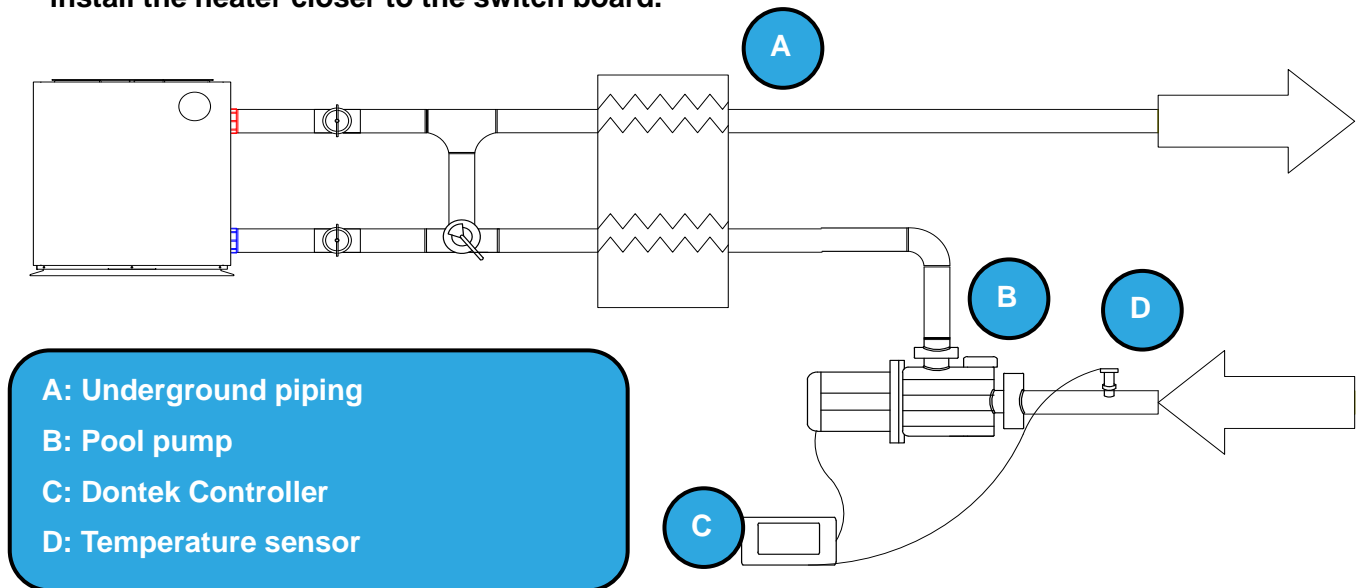

1. It may be impractical to get a new power cable from the house switch board to the pool equipment area due to finished flooring etc., in this case it may be possible to use the existing pipework which connects to the house and install a power cable from there.
2. An external thermostat controller can initiate the existing circulation pump, thus running the heat pump through the flow switch for full temperature control.

Please speak to your installer for more information.

3. No additional wiring to the heat pump is needed internally
4. Timers are set on the external thermostatic controller
5. Set heat pump a couple of degrees above the set point temperature of the external temperature controller.

e. Automation systems and additional controls

For 230V auxiliary outputs, please see Madimack automation bridge (sold separately)
www.madimack.com.au/brochures

The heat pump comes with easy to connect socket labelled as control input

The unit comes prewired with a bridge cable connected. To add an external control to activate the heat pump, remove the bridge and add in a volt free terminal connection. Please check with the automation system provider that the connection is volt free and the best way to install with their set-up.

please see control socket connection diagram for further information around connecting to the socket.)

If the external controller is not initiating the heat pump to operate the display will show the word "OFF"

f. Control socket connection diagram

For Control input connection and Pump control output

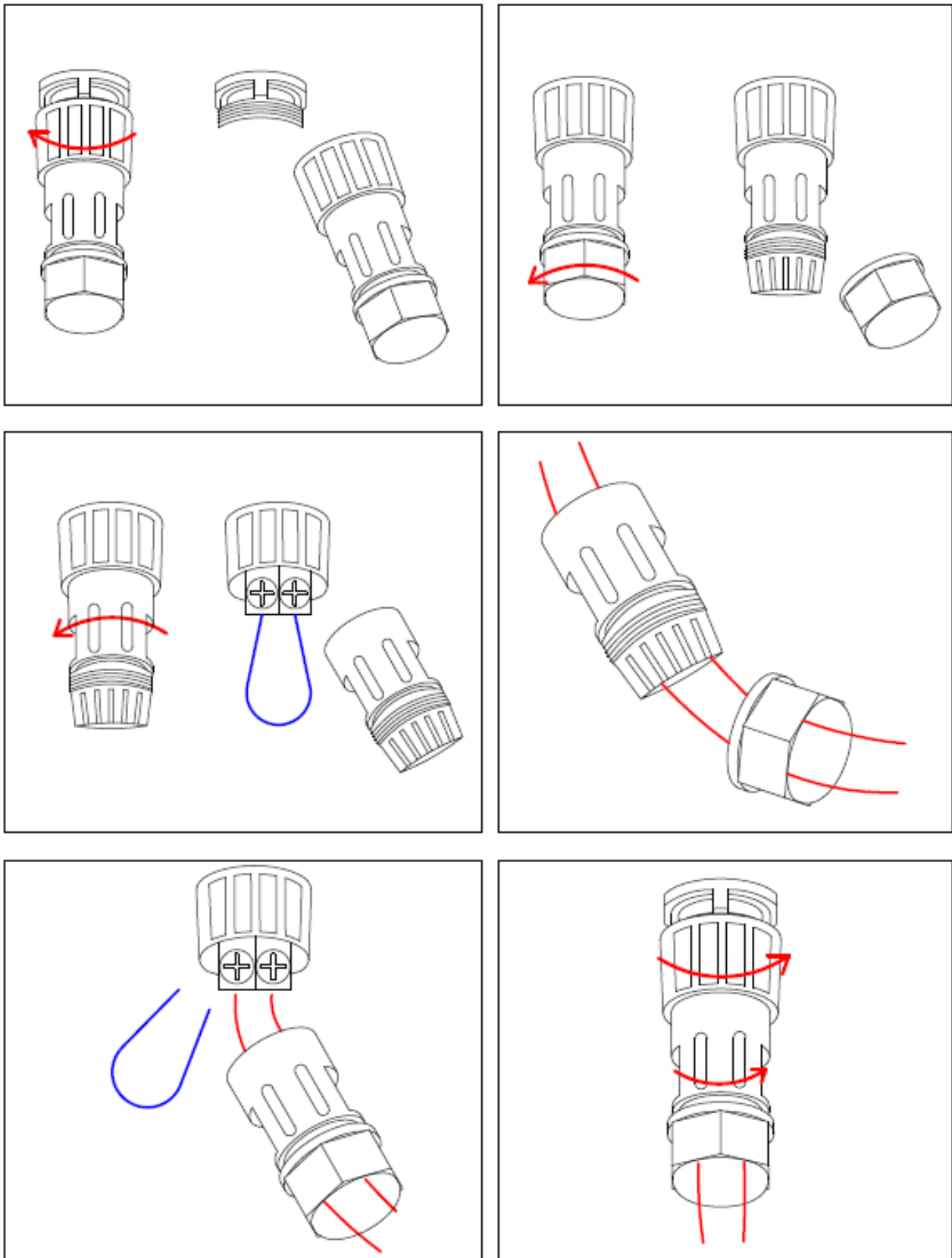

e.

Operation Guidance

1. Display Functions



Symbol	Designation	Function
	ON/OFF	Power On/Off WiFi setting
	Unlock	1. Lock/Unlock Screen 2. Heating mode (18-40°C) 3. Cooling mode (12-30°C) 4. Auto mode (12-40°C)
	Speed Mode	Two modes: Boost Silence
	UP/DOWN	Temperature Setting & Displaying



- Standby mode or Screen lock : Only symbol lights up, screen and other buttons turn darker
- Power off mode : Only symbol will light up, No display on screen.
- The controller has a power-saving mode and will not display bright when locked.
- The controller has a built-in memory so all parameters are saved in the event of power loss
- If the controller displays "OFF" this indicates an external device is holding the unit to not activate.

2. Operation Instruction



a. Screen Lock

- 1) Press “” for 3 seconds to lock or unlock the screen.
- 2) Display automatically locks in no input is detected after 30 seconds.

b. Power On



Press “” for 3 seconds to unlock screen. Press “” to power on machine.

c. Temperature Setting

Press “” and “” to display and set temperature under screen on.

d. Mode Selection

- 1) Heating/Cooling/Auto

Press “” to switch among heating” ”, cooling” ” and auto mode” .

Heating mode “”: Water temperature setting range(18-40°C)



Cooling mode “”: Water temperature setting range(12~30°C)

Auto mode “”: Water temperature setting range(12~40°C)

* When water inlet temperature is higher than setting point, automatic cooling mode starts.

* When water inlet temperature is lower than setting point, automatic heating mode starts.



e. Wi-Fi

1. Download InverGo app from Apple app store or Google Play store.
2. Set up new account, enter WiFi password and click add new device (Enter area code +61 when registering by phone number)
3. When the screen is unlocked, hold  button for 3 seconds, after  symbol will begin flashing.
4. WiFi connection process has now started on the unit.
5. Now press Bind Device on mobile device.
6. System should now have connected within the minute and now enjoy controlling the unit through WiFi.
7. When WiFi is connected  symbol is displayed.
8. To clear the WiFi setting history on machine. When the screen is on, press and hold for 10 seconds, symbol will flash fast for 10 seconds then switch off.





f. Defrost Cycle

- **Automatic active defrosting**

When the machine is operating in low temperatures it is very common for ice to build up on the external coil. The heat pump has a built in defrost protection program which will activate when it senses ice starting to form.

When machine is defrosting,  starts flashing; after defrosting  is on continuously

- **Forced defrosting**

If the heat pump requires manually defrosting for testing or a sensor is faulty please follow these instructions, the machine must be in heating mode and the compressor is working continuously for more than ten minutes, Whilst the unit is running, press  and  on the controller simultaneously and hold for 5 seconds. When the  symbol is flashing, defrost has started, and will continue until the external coil temperature reaches a certain temperature adequate for continued operation. If the  symbol stops flashing forced defrost has stopped.

*Note: the interval between forced defrosting should be more than 30 minutes apart.

Note: Defrost mode usually last for around 15 minutes, during this period, the heat pump fan will stop running, and relatively louder noise will be heard. The heat pump will reverse the refrigeration cycle in an attempt to melt any frost that have formed on the internal components, therefore its totally normal to witness higher condensation rate around the unit (Frost melting) and white smoke coming out of the unit (Water Vapor).

f.

Testing and Parameters

1. Heat Pump checks before use

- a. The air inlets and outlets are free of any debris and are not obstructed.
- b. Refrigeration pipes or components are not installed in a corrosive environment.
- c. Check electric wiring connections are tight and adhere to the electrical schematic
- d. Check for water leaks around the machine and all new water connections





2. Refrigerant leak detection

- a. Leak testing is prohibited in enclosed areas
- b. Any source of ignition is prohibited during leak checks.
- c. Leak detection fluids can be used with most refrigerants but the use of products containing chlorine should be avoided as the chlorine may react with the refrigerant and corrode the copper pipe.
- d. Vacuum the machine completely before welding. Welding should only be carried out by a professional person in a service center.
- e. Please stop immediately if a gas leak occurs, and contact your local service center.

3. Trial Run

- a. The circulation pump must start before the heat pump and stop after the heat pump to avoid any damage occurring to the machine.
- b. In order to protect the heat pump, the machine is equipped with a time lag start function, the fan will run 1 minute earlier than the compressor when starting the machine, and it will stop running 1 minute later than the compressor when power off the machine.
- c. After the heat pump starts, check for any abnormal noises from the machine.

4. Running Status Check

- a. Press and hold  for 5 seconds, a beep sound should be heard, and it will enter into running status mode
- b. Use  and  to switch through the different
- c. Press  again to quit can running status mode

Symbol	Content	Unit
C0	Inlet water temp	°C
C1	Outlet water temp	°C
C2	Ambient temp	°C
C3	Exhaust temp	°C
C4	Outer coil pipe temp	°C
C5	Gas return temp	°C
C6	Inner coil pipe temp	°C
C9	Radiator temp	°C
C10	Electronic Expansion Valve Opening	P

1. Parameters Checking

1.1 Press “

1.2 Press “

1.3 Press “

2. Modify parameters

2.1 In "parameter checking" status, press “

2.2 In "parameter setting" state, press “

2.3 Press “

31

3. Parameter Table

NO.	Content	Adjust range	Step length	Default
P0	Water pump running way	0 : Continuation 1 : Water temp control 2 : time/water temp control	1	2
P1	Time setting (only available when the water pump running way is set to "2")	10 ~ 120min	5 min	60 min
P2	Compressor continuously running time in defrosting mode	30 ~ 90min	1min	35 min
P3	Defrosting start temp	-17 ~ 0°C	1°C	-7°C
P4	Defrosting running time	1 ~ 12min	1min	12 min
P5	Defrosting quit temp	8 ~ 30°C	1°C	13°C
P6	Single pump option	On/off 50 ~ 100	1	off
P10	Compressor speed control	0 : Auto, 1 : Manual	1	0
P12	Electronic expansion valve overheat level (heating)	-10 ~ 20	1	3
P13	Electronic expansion valve overheat level (cooling)	-10 ~ 20	1	5
P14	Electronic expansion valve manual/auto	0 : Auto, 1 : Manual	1	0
P15	Electronic expansion valve opening setting (heating)	50 ~ 240	2P	175 (H5)
P16	Electronic expansion valve opening setting (cooling)	50 ~ 240	2P	175 (H5)
P20	Power off memory function	0 — NO, 1 — YES	1	1

g.

Commissioning

1. Flow Rates

OPTIMUM FLOW RATE DIFFERENTIAL FROM INLET TO OUTLET IS BETWEEN 2-3 DEGREES

Each Pool Heat Pump has a minimum flow rate requirement please check the specification table to ensure the circulation pump in use is adequately sized.

Calibrating the flow rate

By using the running status function on the touch controller, it is easy to calibrate the check valves installed for optimum flow rates through the heat pump.

Madimack Heat Pumps have a built-in flow switch which will deactivate the heating function if not enough water flow is detected. The Heat Pump has a large range operation up to a seven-degree differential. If the temperature differential is above 7 degrees, the built-in flow switch or E6 Error will be displayed indicating not enough flow detected.

Recommended procedure

- a. Open all isolating valves
 - b. Fully close the by-pass and switch the unit on to max temp.
 - c. Wait 3-4 minutes until heat pump is at 100% Capacity
 - d. Check inlet and outlet temperature through on-screen controller (Check "Running status check" in the previous section to obtain C0 and C1 values)
 - e. Open the by-pass valve to increase temperature differential (The difference between C0 and C1 values)
 - f. Close the by-pass valve to decrease temperature differential (The difference between C0 and C1 values)
 - g. Once optimum temperature difference (2-3 C) achieved lock position of by-pass if possible.
-

Checklist:

- Unit has been installed level
- Minimum ventilation requirements are correct to standards shown in appendix K
- Condensation drainpipe has been connected and drains away from unit
- Rubber feet have been placed underneath unit
- Warranty registration details have been filled out in section L
- Temperature differential has been calibrated between 2-3

h.

Maintenance



“SWITCH OFF” power supply to the heater before cleaning or examination

- 1) In the winter season when unit is not operating for long periods of time or if prone to freezing.
 - a. Cut off power supply to prevent any machine damage.
 - b. Drain water clear of the machine.
 - c. Cover the machine body when not in use.

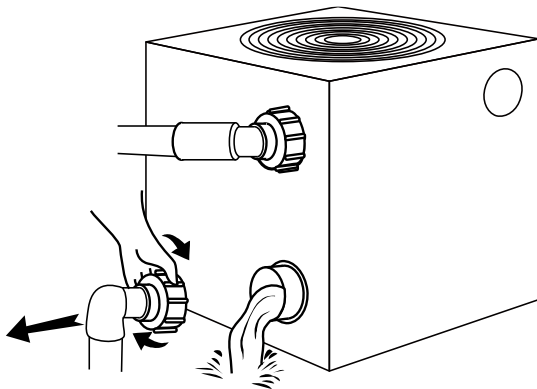

!!IMPORTANT:

Unscrew the water nozzle of inlet pipe to let the water flow out.

When the water in machine freezes in winter season, the titanium heat exchanger may be damaged.

- 2) Only clean this machine with household detergents or clean water, NEVER use gasoline, thinners, or any similar fuel.
- 3) Check bolts, cables, and connections regularly.
- 4) If repair or scrap is required, please contact authorized service center.
- 5) Do not attempt to work on the equipment by yourself. Improper operation may cause danger.
- 6) To reduce risks, safety inspections must be carried out before the maintenance or repairing for heat pumps with R32 gas.

i.

Troubleshooting for common faults

1. Repairing Guidance



WARNING!
If repairs or removal is required,
contact authorized service center.

Requirements for Service Personnel

- a. Any person who is involved with working on or breaking into a refrigerant circuit should hold a current valid certificate from an industry-accredited assessment authority, which authorizes their competence to handle refrigerants safely in accordance with an industry recognized assessment specification.
- b. Do not attempt to work on the equipment by yourself. Improper operation may cause danger.
- c. Strictly comply with the manufacturer's requirements when charging R32 gas and equipment maintenance. This chapter focuses on special maintenance requirements for swimming pool heat pump with R32 gas. Please refer to the technical service manual for detailed maintenance operation.
- d. Vacuum system completely before welding. Welding should only be carried out by professional person in a service center.

2. Problems without an error code

Failure	Reason	Solution
Heat pump doesn't run	No power	Wait until the power recovers
	Power switch is off	Switch on the power
	Fuse is broken	Check and change the fuse
	The breaker is off	Check and turn on the breaker
Fan running but with insufficient heating	Evaporator blocked	Remove the obstacles
	Air outlet blocked	Remove the obstacles
	3-minute start delay	Wait patiently
Display normal, but no heating	Set temperature too low	Set proper heating temp.
	3-minute start delay	Wait patiently
<p><i>***If above solutions don't work, please contact your installer with detailed information and your model number. Please don't try to repair it yourself. ***</i></p>		

Note

If the unit frequently trips the circuit breaker, please stop the machine immediately by switching off the main power and contact your dealer or local repair centre.

Error	Component corresponding	What did the error detect?	Solution
E1	High pressure protection	High gas pressure switch	1. Check the water flow from the filtration pump and ventilation clearances. 2. Check high pressure switch is closed circuit 3. Replace PCB 4. replace inverter board
E2	Low pressure protection	Low gas pressure switch	1. Check the water flow from the filtration pump and ventilation clearances. 2. Check low pressure switch is open circuit 3. Replace PCB 4. replace inverter board
E3	No water protection	Low water flowrate	Check the water flow in pipes, and filtration pump is running. Check filters, skimmer basket, back wash Check the bypass or valves have not been adjusted since commissioned Check the Water flow switch
E4	3 phases sequence protection	Electrical power connection	Check the power connection to the pump
E5	Power supply excesses operation range (Not failure)		1). Recover when back to the normal power 2). Replace PCB
E6	Excessive temp difference between inlet and outlet water (Insufficient waterflow protection)	High temperature difference	Check the water flow in pipes, and filtration pump is running. Check the bypass is opened and unit is commissioned Check the Water flow switch
E7	Water outlet temp too high or too low protection	Water flowrate in pipes	Check if there is any blockage in the inlets, outlets, and through the pipe
E8	High exhaust temp protection	Compressor overheating	Check if refrigerant gas is leaking, check the connection of the sensor, might need to change if faulty, check the compressor of the pump
Eb	Ambient temperature too high or too low protection (not failure)	Out of the heat pump's capacity to withdraw heat from the atmosphere	Out of application range
Ed	Anti-freezing reminder (not failure)		Wait for automatic recovery
F1	Compressor drive module failure	Lack of phase	Check the voltage and the frequency conversion
F2	PFC module failure	PFC circuit	Check the PFC switch circuit if short or not
F3	Compressor start failure	Compressor circuit	Check the compressor wiring if its correct or if there is any short circuit
F4	Compressor running failure	Compressor circuit	Check the compressor wiring if its correct or if there is any short circuit
F5	Inverter board over current protection		1). Wiring 2). Inverter board 3). PCB
F6	Inverter board overheat protection	Inverter board high temp	Check the current flowing it might need to
F7	Current protection		1). Power off and restart 2). Inverter board 3). Compressor
F8	Cooling plate overheat protection		1). Power off and restart 2). Check fan motor 3). Check cooling plate
F9	Fan motor failure	Fan motor	Check the fan motor wiring, check if the fan is broken or loose

Fb	Power filter plate No-power protection	Power filter not working	Single Phase Model 1). Replace Inverter board 3 Phases Model 1). Replace power filter plate
FA	PFC module over current protection	Solar inverter voltage change Power black out Power surge	1). Initial power testing has completed. Power off and restart (happens install with solar PV) 2). Replace Inverter board
P1	Water inlet temp sensor failure	The water inlet temperature sensor is either damaged or running a short circuit	Check the Temperature sensor at the water inlet, might need to be changed
P2	Water outlet temp sensor failure	The water outlet temperature sensor is either damaged or running a short circuit	Check the Temperature sensor at the water outlet, might need to be changed
P3	Gas exhaust temp sensor failure	The sensor is running a short circuit, damaged, or not fixed properly	Check the gas exhaust Temperature sensor, might need a replacement
P4	Evaporator coil pipe temp sensor failure	The sensor is running a short circuit, damaged, or not fixed properly	Check the evaporative coil pipe Temperature sensor, might need a replacement
P5	Gas return temp sensor failure	The sensor is running a short circuit, damaged, or not fixed properly	Check the Gas return Temperature sensor, might need a replacement
P6	Cooling coil pipe temp sensor failure	The sensor is running a short circuit, damaged, or not fixed properly	Check the cooling coil pipe Temperature sensor, might need a replacement
P7	Ambient temp sensor failure	The sensor is running a short circuit, damaged, or not fixed properly	Check the Ambient Temperature sensor, might need a replacement
P8	Cooling plate temp sensor failure	The sensor is running a short circuit, damaged, or not fixed properly	Replace inverter board
P9	Current sensor failure	The sensor is running a short circuit, damaged	1). Replace inverter board for single phase model 2). Replace power filter plate for 3 phases model

j.

Wi-Fi operation

For video tutorials and further help please visit www.Madimack.com.au FAQ for all you need to do and full walkthrough. It is crucial that the WiFi is over the machine and is of a high power, the WiFi is a cloud based solution and needs the WiFi to be active on the machine for it to receive a signal.

1. 1) Make sure to switch off your data package on your phone prior pairing the heater, Mobile data can interrupt the connection process in some cases therefore failing to connect the unit.
2. Your phone should be displaying full Wi-Fi strength with -50 DB > to ensure that you have enough signal strength for the heater to connect
3. To reset the Wi-Fi settings on the heater, do the following:
 - a) Unlock the controller by holding the lock button on the far left for 3 seconds, the buttons will illuminate indicating that the controller is unlocked.
 - b) Hold The power button (for about 10 seconds) till you see the Wi-Fi signal on the controller flashing slowly
 - c) When Wi-Fi signal blinking stop means that the settings have been reset, follow the same instructions below to pair the heater with your mobile device

1 InverGo Download



Android



iOS



2 Account Registration

Register by e-mail or third-party application.

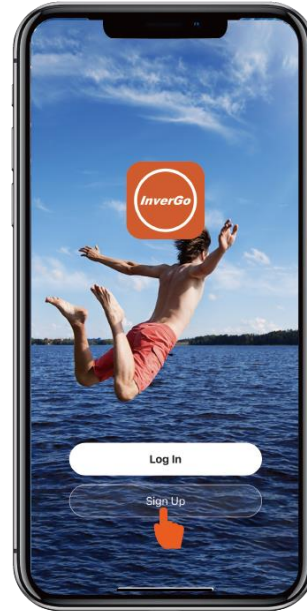

a. E-mail registration.

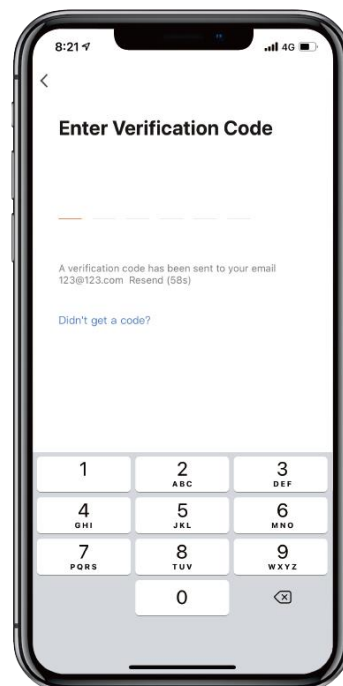
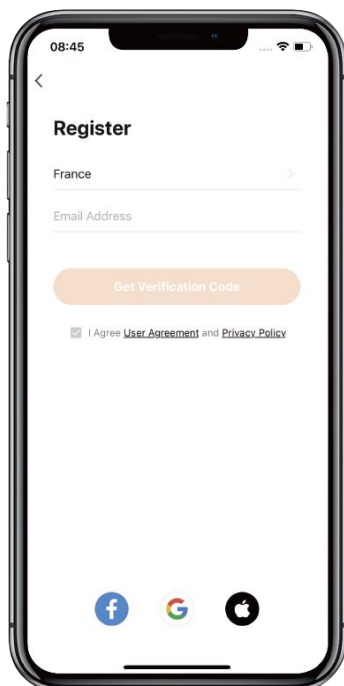

b. Register through third-party application

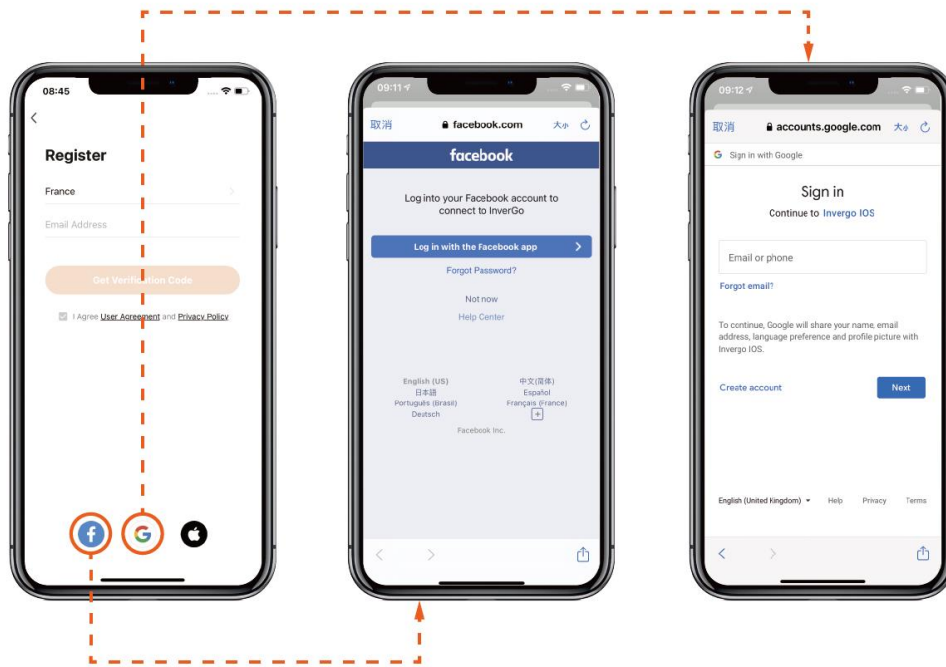

3 Create Family

Please set family name and choose location of device.

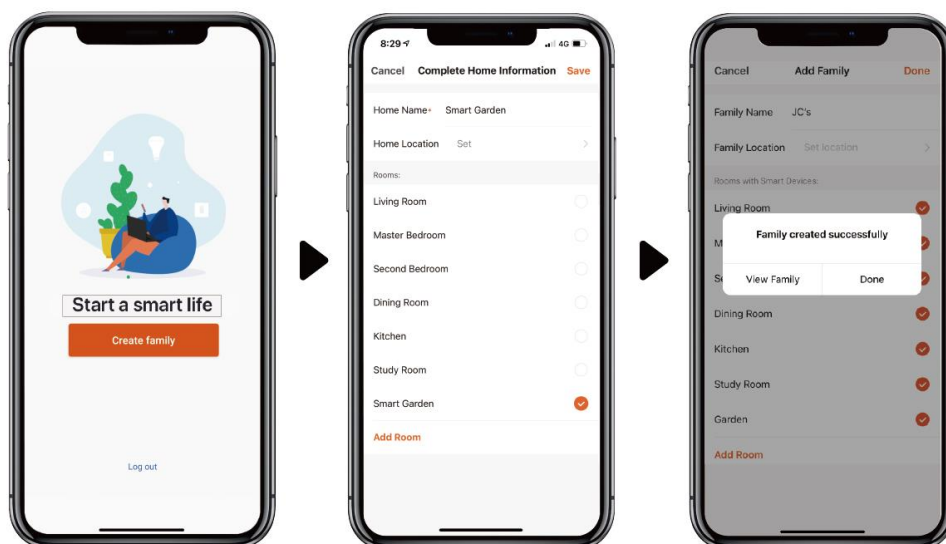

4 APP Pairing

a. With Bluetooth

1. Please confirm that you're connected to Wi-Fi and your Bluetooth is on.
2. Click "Add Device", and then follow the instructions to pair device.

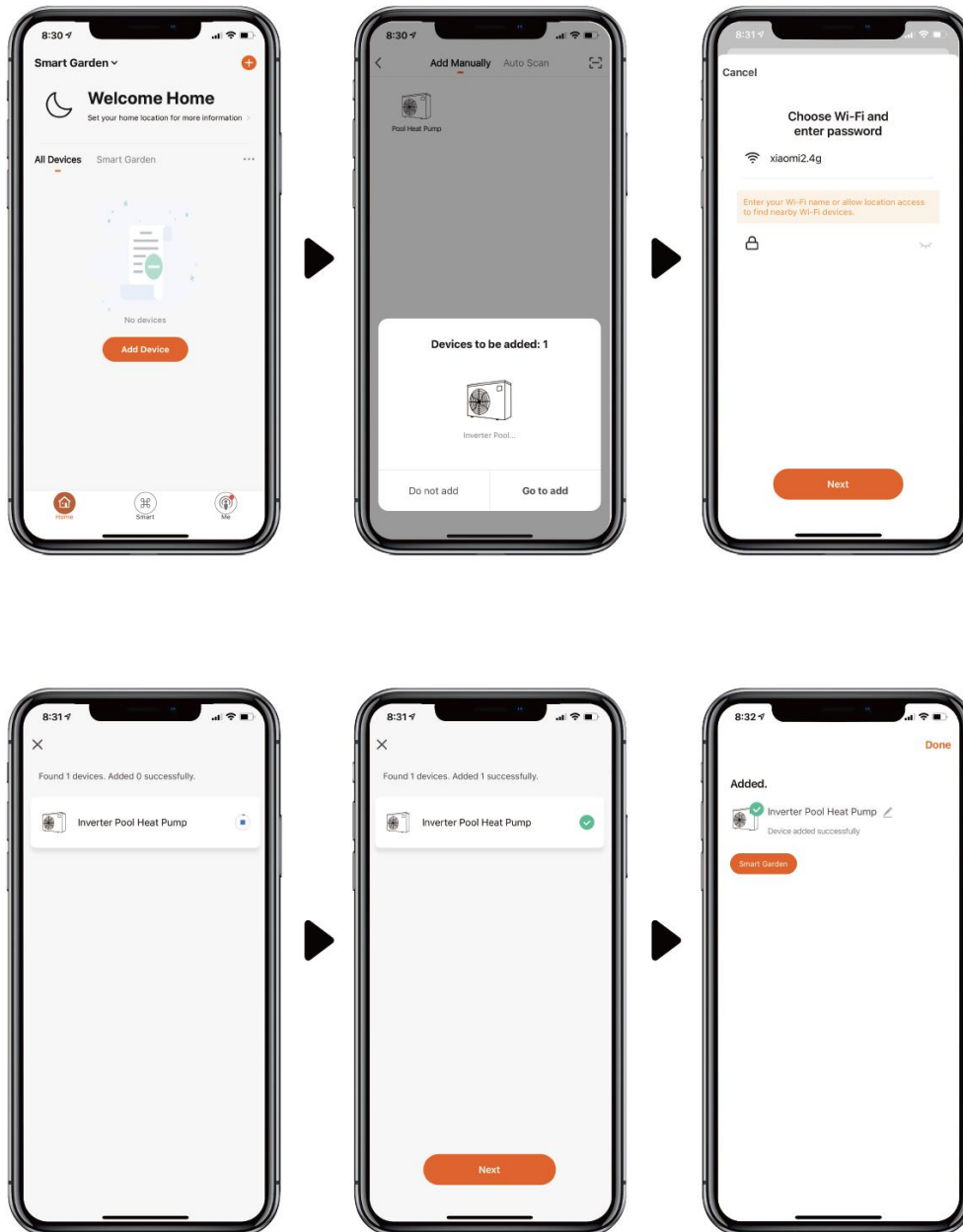

b. With Wi-Fi

1. Please make sure you are connected to Wi-Fi.

2. Press "Ⓜ" for 3 seconds to unlock the screen. Press "⏻" for 3 seconds and release. After hearing "Beep", enter Wi-Fi password in app. During connection, "📶" will flash. Once the app connects to Wi-Fi successfully, "📶" will display.



3. Click "Add Device", and then follow the instructions to pair device.

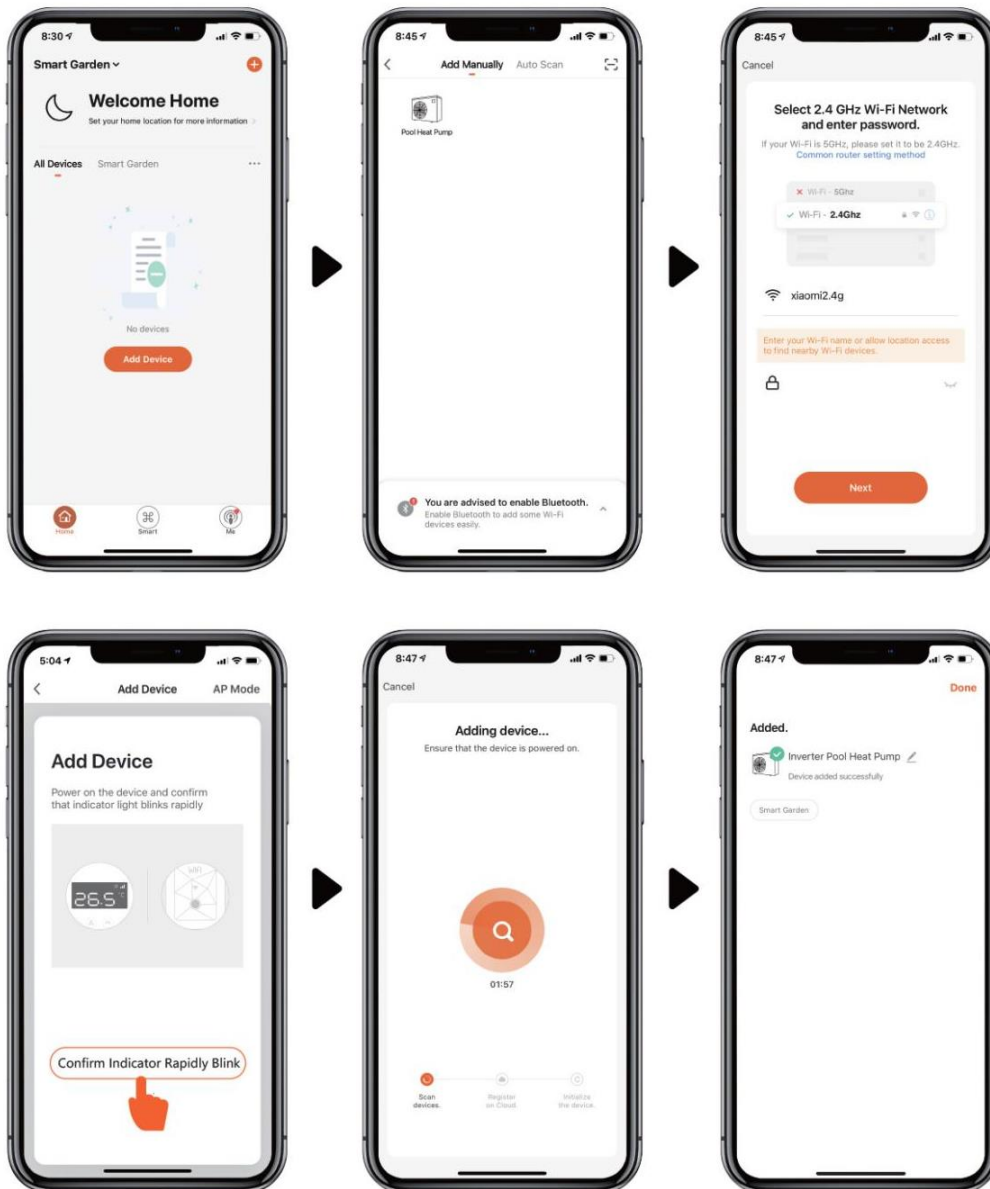

5 Operation

1. For heat pump with Heating function only:

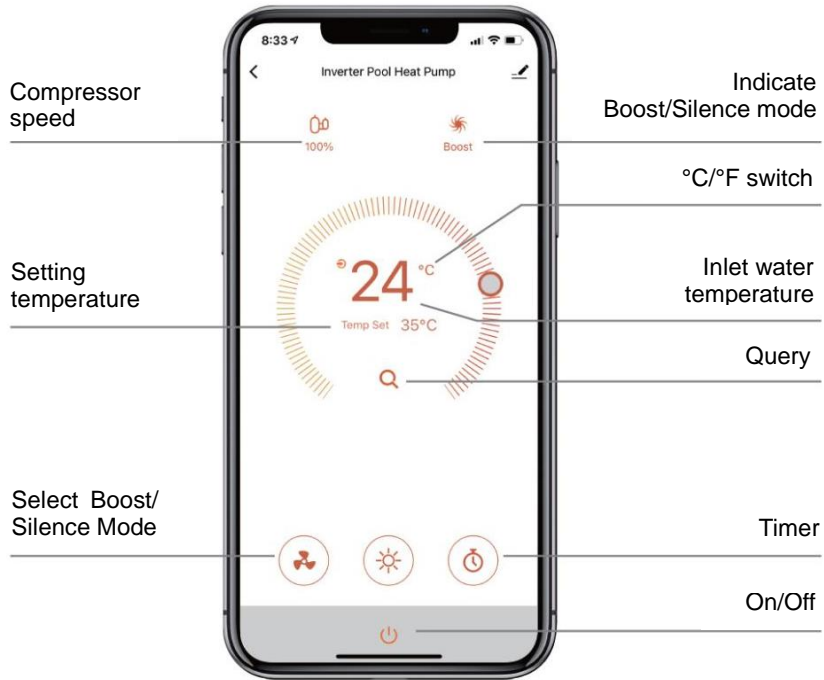

2. For heat pump with Heating&Cooling function:

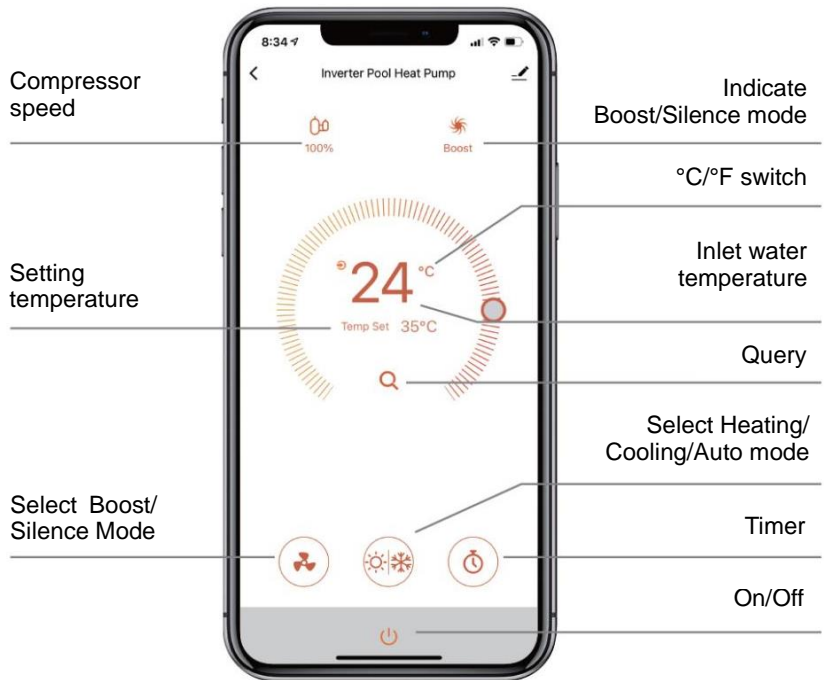

This Warranty applies to domestic and commercial products purchased and installed in Australia.

Our goods come with guarantees that cannot be excluded under the Australian Consumer Law. You are entitled to a replacement or refund for a major failure and for compensation for any other reasonably foreseeable loss or damage. You are also entitled to have the goods repaired or replaced if the goods fail to be of acceptable quality and the failure does not amount to a major failure. Your Australian Consumer Law guarantees, and similar statutory rights, are called the “Owner’s Statutory Rights” in this Warranty.

THE RIGHTS GIVEN BY MADIMACK AUSTRALIA WARRANTY ARE IN ADDITION TO THE OWNER’S STATUTORY RIGHTS.

The Madimack Pty Ltd (“Madimack”) equipment listed on the back of this card is warranted by Madimack against defects in design, materials and workmanship for a period of up to 2 Years from the date the equipment is purchased by the original owner.

Equipment defects covered by this Warranty will be repaired or replaced at the discretion of Madimack (subject to the Owner’s rights under the Australian Consumer Law with respect to major failures) without cost to the owner for parts or direct repair labour. The repair or replacement shall be performed during normal business hours by Madimack or a repair agent authorised by Madimack.

Any Madimack parts or Madimack equipment replaced under this Warranty will be warranted in accordance with the provisions of this Warranty for the remainder of the original warranty period or 12 months from the completion of the repair, whichever is the greater. Except where inconsistent with the Owner’s Statutory Rights and the rights given by this Warranty, all other warranties and all liability of Madimack for any loss or damage direct and consequential is expressly excluded.

This Warranty DOES NOT cover: -

- a) Damage or problems or unsatisfactory performance caused to the equipment by faulty or incorrect external electrical wiring, incorrect power supply, voltage fluctuations, over voltage transients or electromagnetic interference not originating within the equipment.
- b) Damage or problems resulting from incorrect or poor installation.
- c) Damage or problems caused by the use of an accessory, component or equipment not supplied by Madimack.
- d) Damage or problems caused by storm, fire, flood, vandalism, misuse, negligence, Acts of God, earthquake, war, vermin, foreign matter entering the equipment (e.g. dirt and moisture) or any other outside agency.

- e) Damage or deterioration to the external surfaces or refrigeration coils caused by normal weathering or corrosive atmospheric conditions.
- f) Any costs or additional labor associated with gaining acceptable service access to equipment installed in restricted or unsafe (e.g. high) locations.
- g) Freight charges (including insurance) or travelling cost for repairs performed outside the area normally serviced by Madimack or a repair agent authorized by Madimack.
- h) Equipment which has been installed in a transportable or mobile application (e.g. caravan or boat).
- i) Equipment which has been re-installed in a transportable or mobile application (e.g. caravan or boat).
- j) Equipment which has been re-installed at a location other than the original location.
- k) Any consumable item (e.g. batteries, filters, and belts) supplied with the equipment unless the item is shown to be defective at the time of purchase.
- l) Damage or problems or unsatisfactory performance resulting from operation in an environment where the climatic comfort of humans is not the primary function of the equipment.
- m) Damage or problems or unsatisfactory performance resulting from operations at conditions outside the operating conditions specified in the Madimack technical or sales literature applicable to the equipment.
- n) Damage, problems or unsatisfactory performance resulting from misapplication of the equipment.

Where this Warranty does not apply, the Owner's rights are limited to the Owner's non- excludable Statutory Rights.

Owner's Responsibility

The owner is responsible for the correct operation and regular maintenance of the equipment as listed below. The correction of any non-product fault or problem is not covered by this warranty.

- a) Operation and maintenance of the equipment in accordance with the operating instructions.
- b) Regular cleaning of the air filter(s) and replacement where necessary.
- c) Ensuring that the air inlet and outlet on the outdoor unit is kept clear of any obstructions (e.g. dirt, leaves, plants)
- d) Ensuring that the condensate drain is kept clean.
- e) Replacement of exhausted batteries.
- f) The application of additional corrosion protection if the product is installed in a corrosive environment (e.g., Industrial pollution, sea air).

Owner's Statutory Rights

In respect of any goods supplied under the contract which are not of a kind ordinarily acquired for personal domestic or household use or consumption, unless the owner establishes the following limitation of liability would not be fair and reasonable, the liability of Madimack for any defect of design, materials or workmanship will be limited to any of the following as determined by Madimack: -

- a) Replacing the equipment or supplying equivalent equipment;
- b) Repairing the equipment;
- c) Paying the cost of replacing the equipment or acquiring equivalent equipment;
- d) Paying the cost of having the equipment repaired.

Making a claim

The following steps should be taken when making a warranty claim with Madimack Pty Ltd.

- 1) Owners experiencing issues with their system are to contact Madimack Pty Ltd service departments online portal to and provide the requested information.
- 2) A service agent will review the provided information and will contact you on the provided phone number to try and solve the issue
- 3) If the issue cannot be dealt with over the phone, owners will be supplied with details of service agent in their area
- 4) Owners will need to contact and deal with service agents directly in relation to the booking in and payments of works related to the service or repair of their Madimack Pool Heat Pump
- 5) Owners can claim reimbursement for costs of works covered under the product warranty when completed by an approved Madimack Service Agent. When making a claim, owners will need to provide the following documents
 - Proof that you are the original system owner – original invoice showing owner name and property address
 - Copy of invoice from an approved Madimack approved service agent
 - For a major defect a copy of the report for major defects from approved Madimack Service agent
 - All Service Claim Submissions will be processed and reimbursement on validated claims paid into owner nominated account within 7 business days.

Product Purchase Warranty Registration



Please complete all the details below from the installer and store this card along with the purchase docket in a safe place.

Please take 2 or 3 photos of the installation and with this information upload them online at <https://www.madimack.com.au/warranty-registration> or use the barcode scanner to go direct to the page.

Supplied by	
Date of Purchase	
Installed by	
Installer No (if applicable)	
Date of Install	
Owners full name	
Address of Premises	
Telephone number	

Make	
Model	
Serial	
Commissioning	
By pass valve fitted?	
Temperature difference	
Notes	

madimack^o

AQ01CV-R32-V22-2